

These are some still drawings I have done over the years from ideas and designs around the forums and elsewhere. I thought I would throw them all together in one file for others to gawk at.

This is not an exhaustive list of possible still types and designs. For example, there are no plate stills in here.

There is nothing new here, except maybe the offset VM near the end, and the condenser for the Offset CM (Manu) still.

These drawings are schematic drawings about the basic principle, not full engineering drawings, (though they may have some details on them). Most of the basic designs are well established and tested, but some variations may need fine tuning, and some have not been tested at all (as far as I know), like the the offset VM, and the condenser for the Offset CM (Manu) still.

I don't have time to make any serious notes on them. But I think the drawings are pretty self explanatory.

Also, the document formatting is not perfect, but I just ain't got the time to make it otherwise.

Hook  
Dec 2010

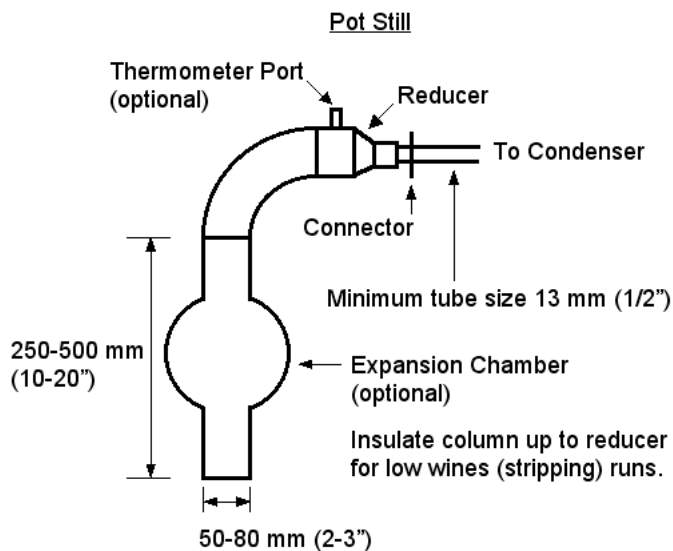

Pot still with thumper

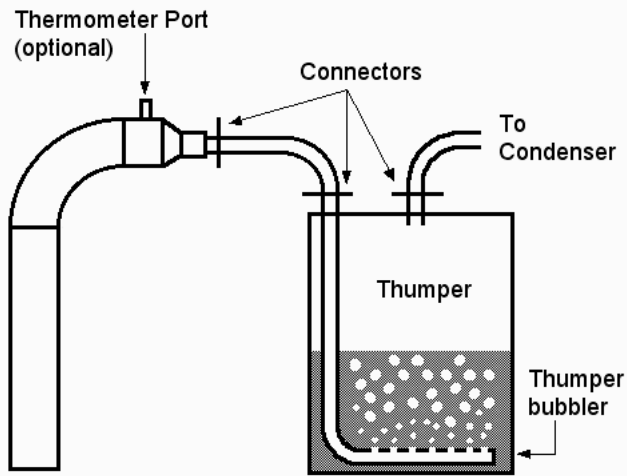

It is very important that the holes in the thumper bubbler are never blocked. If stilling a wash containing grain, fruit or molasses then the holes in the bubbler must be big enough to let any solids through if the wash boils over ('pukes') into the thumper.



Coil in a barrel condenser  
(worm condenser)

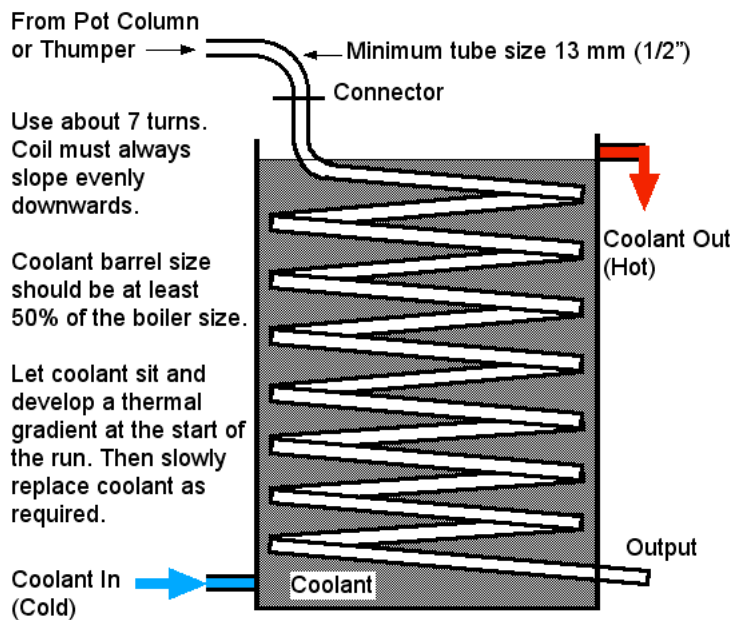

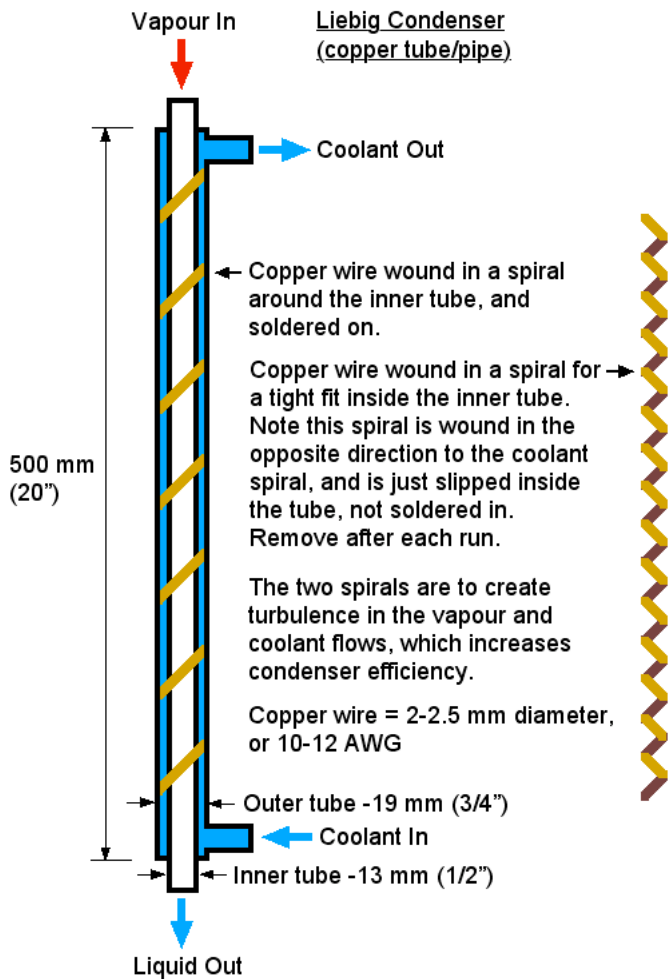
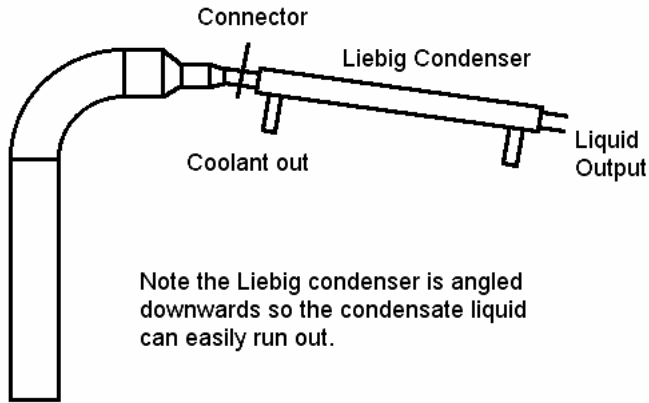

Form the inner spiral into a slight 's' shape overall. This will keep it in place inside the condenser



.....



.....  
.....

Fractionating Column  
(power management, no column insulation)

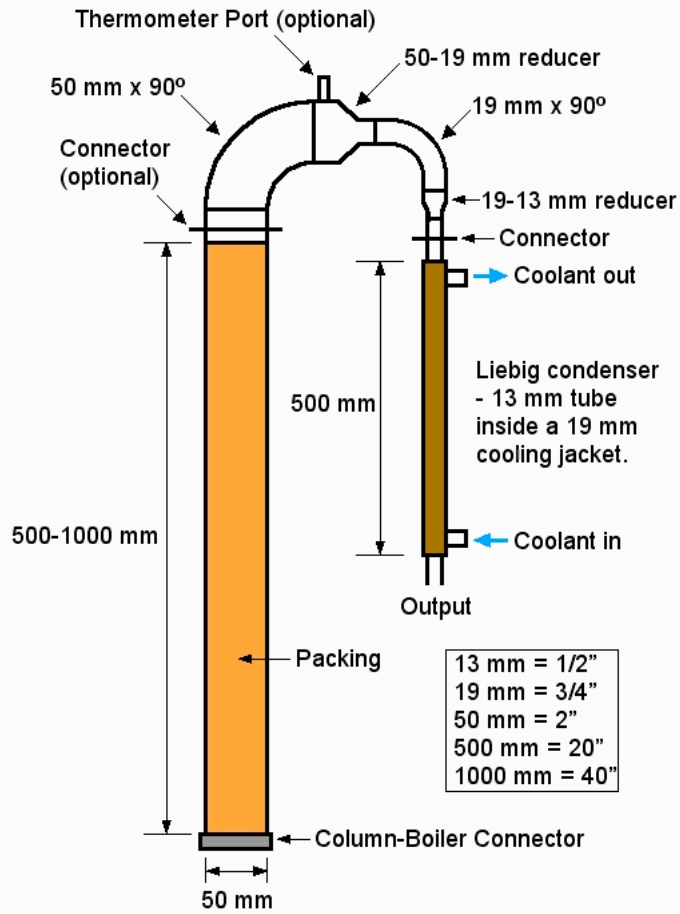

CM Column - Crossed tubes condenser

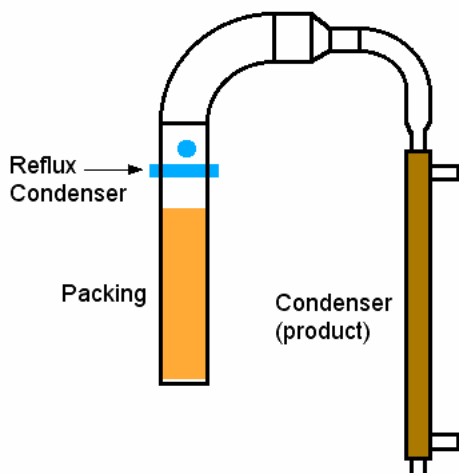

Avoid any column design with coolant ('reflux') lines running through the packing, typically lower down in the column, like this:

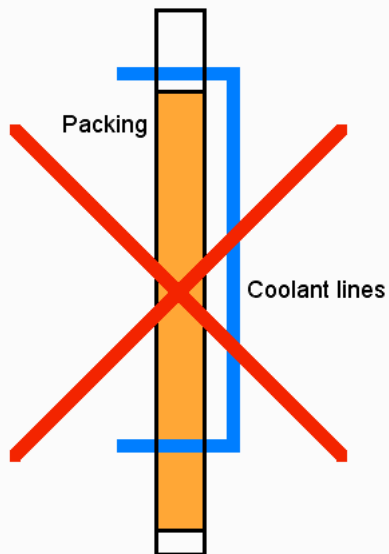

All forced reflux condensing must take place above the packing.

**Offset CM (Manu Still)**

Adjust condenser position to vary reflux ratio.  
In increases reflux ratio. Out decreases reflux ratio.

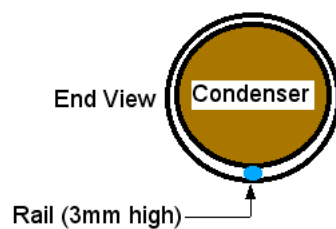
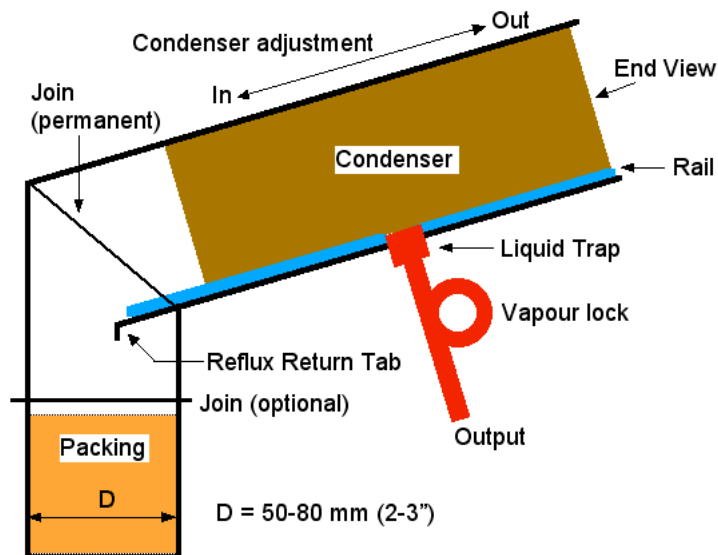

.....

Condenser for Manu Offset CM Still

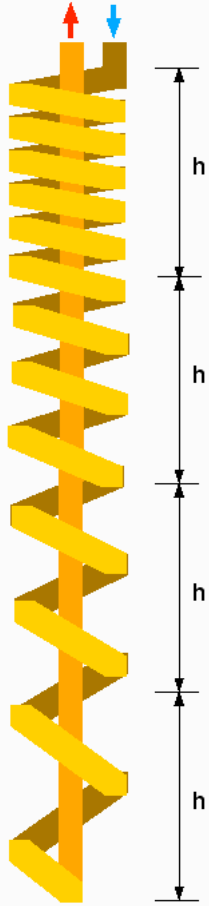

**Slanted Plate LM**  
(Internal reflux return)

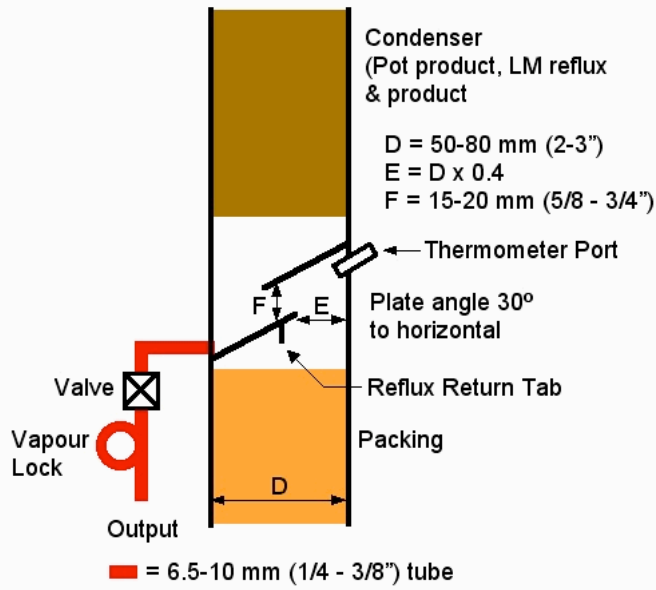

**Slanted Plate LM**  
(External reflux return)

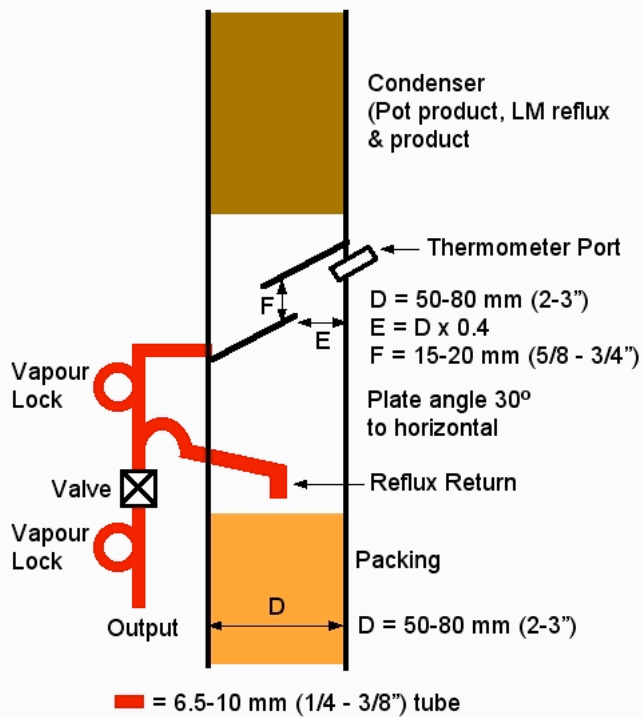



Alternative internal vapour lock  
for the reflux return path

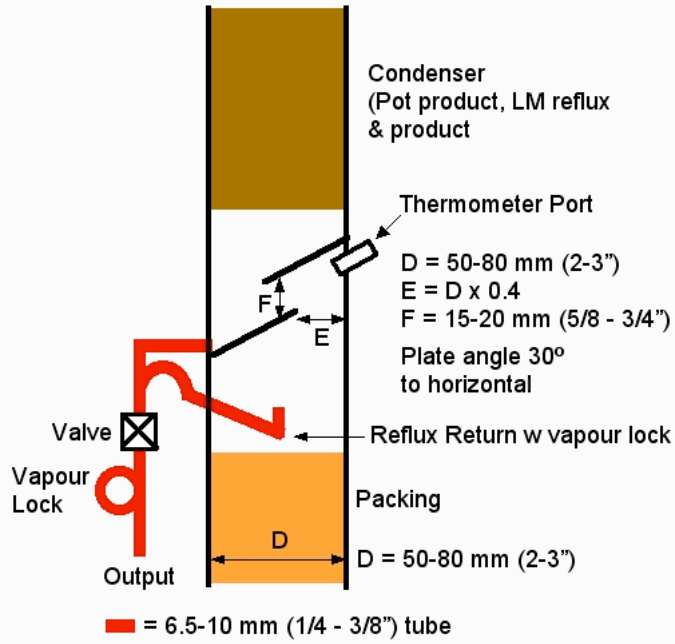

Input (liquid)

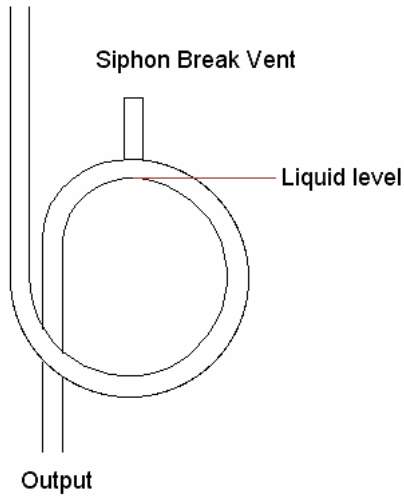

Liquid Levels  
(internal reflux return)

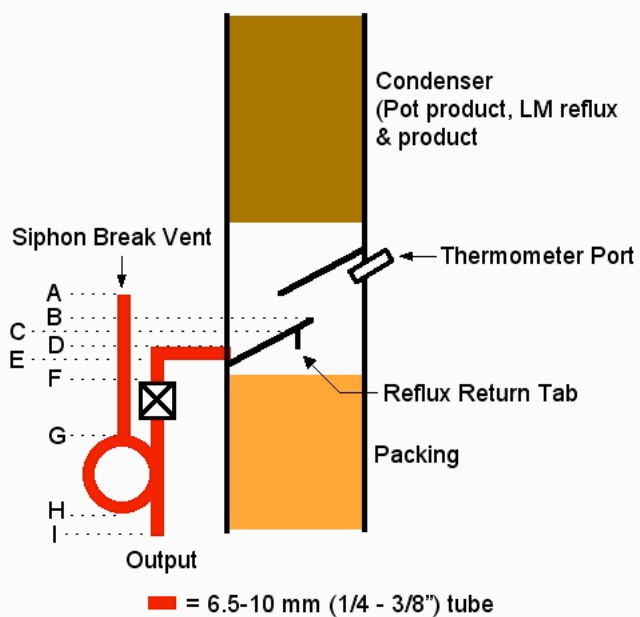

Note the vertical relationships between different components of the liquid management system, A - I.



Liquid Levels  
(external reflux return)

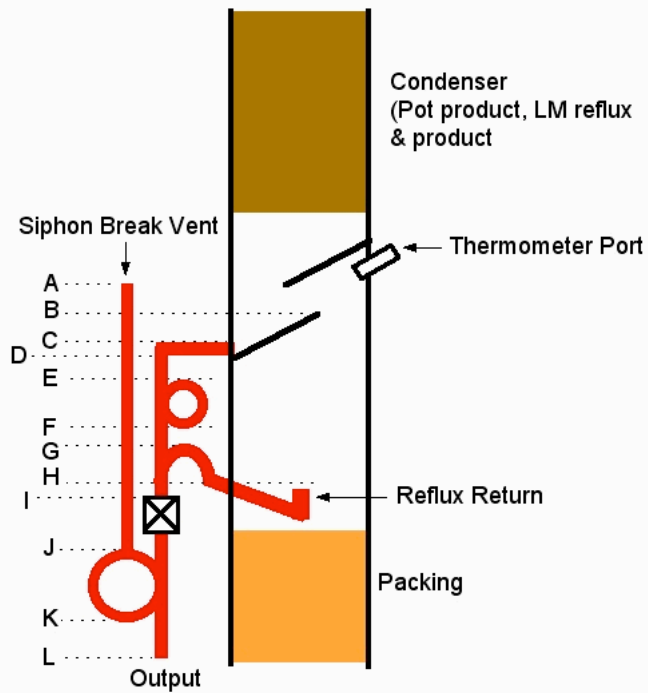

■ = 6.5-10 mm (1/4 - 3/8") tube

Note the vertical relationships between different components of the liquid management system, A - L.

The distance from G to H must be at least 2.5 times the diameter of the tube.



LM Head  
(one reducer, tee trap,  
internal vapour lock)

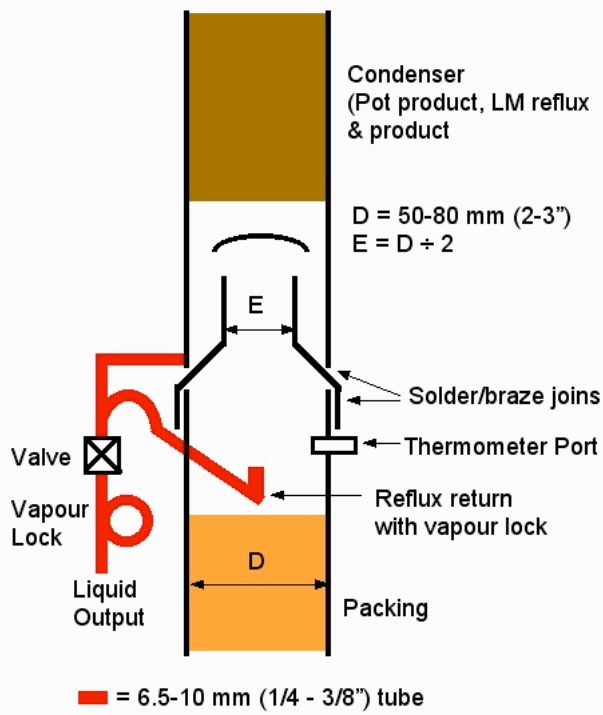

LM Head  
(one reducer, tee trap)

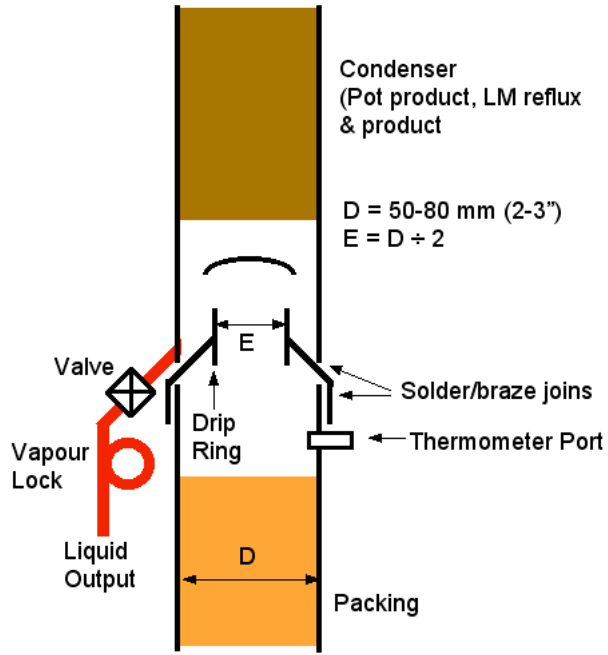

■ = 6.5-10 mm (1/4 - 3/8") tube

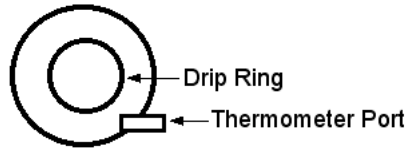

LM Head  
(2 reducer, tee trap,  
external vapour lock)

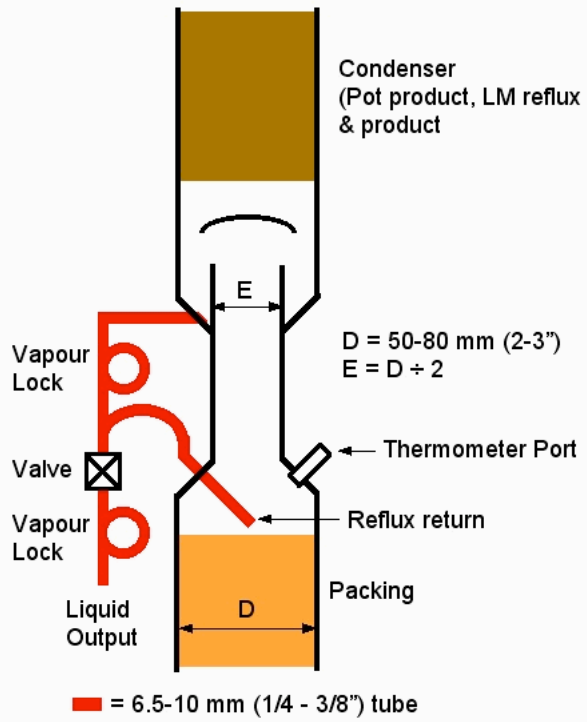

LM Head  
(2 reducer, tee trap)

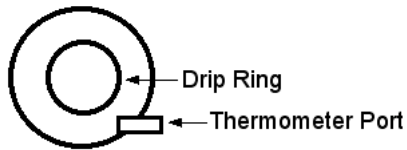
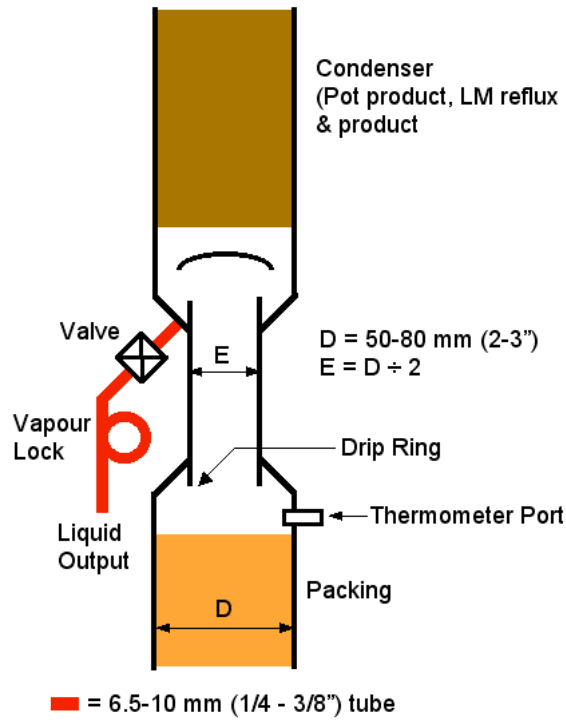

45° Offset LM

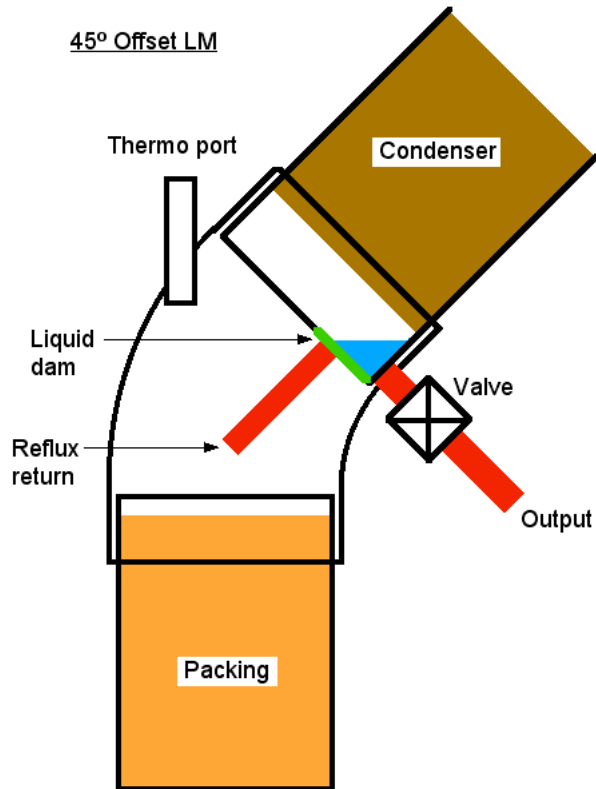

Horizontal Condenser (LM)

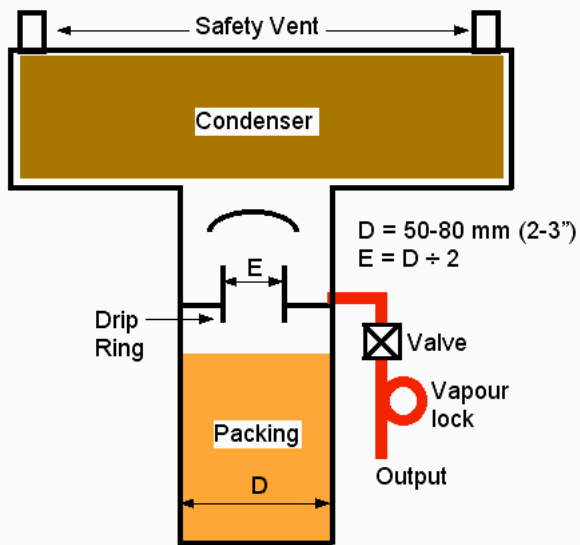



Liquid Trap or Tee Trap

Liquid Trap 1

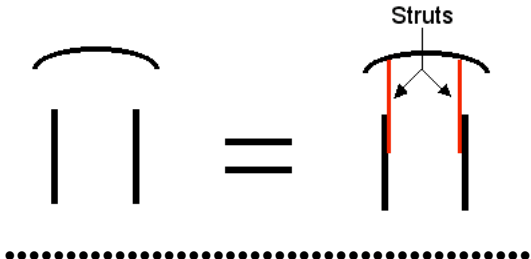

Liquid Trap 2

To fit the tee inside the column  
cut it along the red lines:

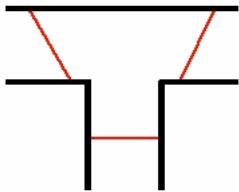

To get this shape...



Liquid Trap 3

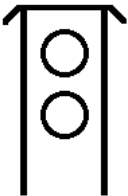

LM-CM Head  
(tee trap)

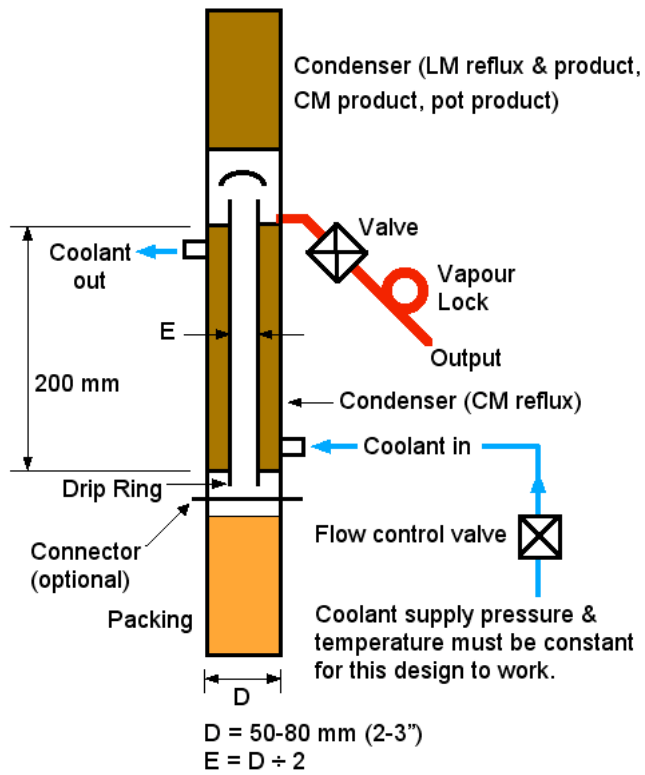

VM Head  
(Nixon-McCaw, reduced tee)

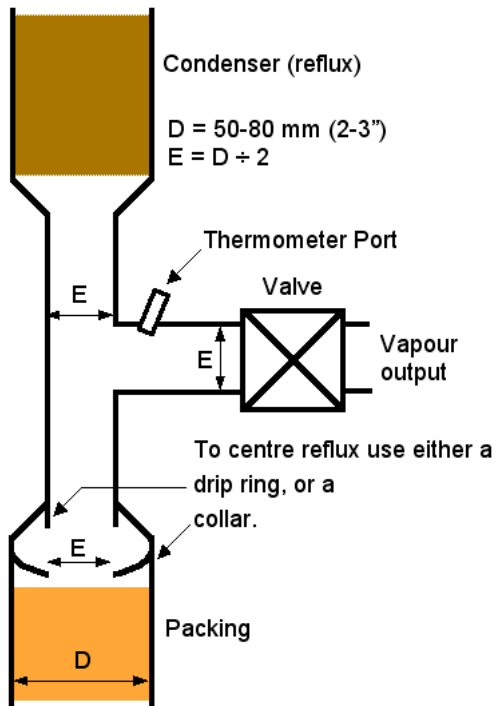

VM Head  
(non-reduced tee)

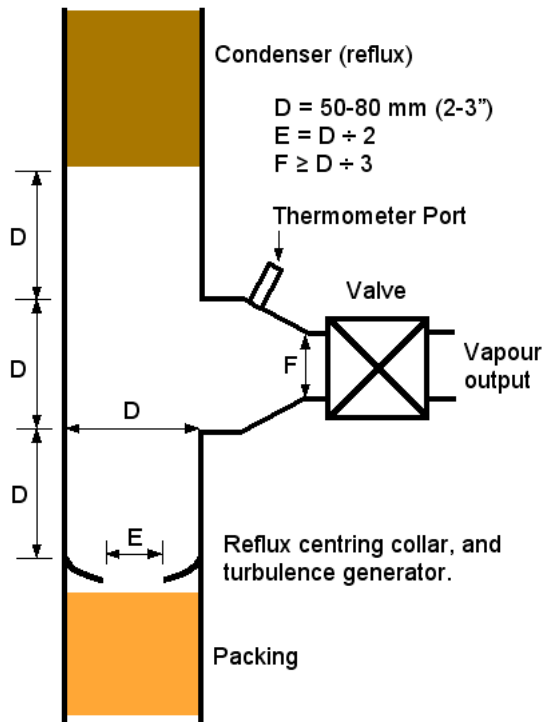

There is a type of tee called a sweep tee, which might be a better choice for this type of VM.

Straight Tee

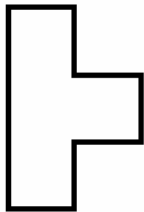

Sweep Tee



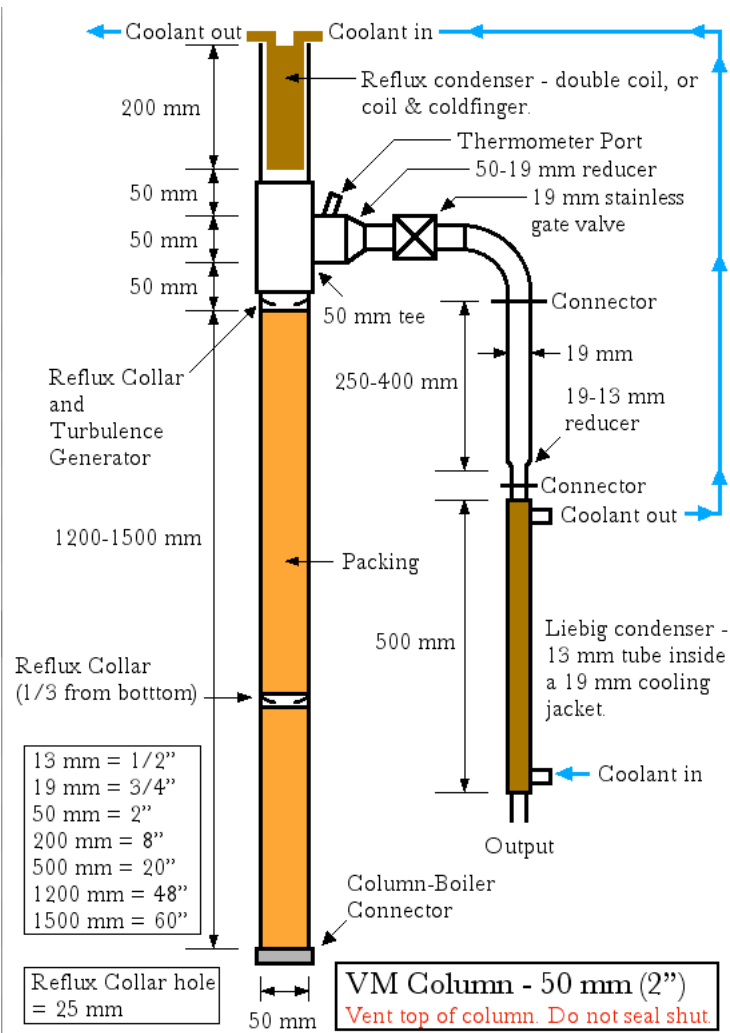

Reflux collar spacing

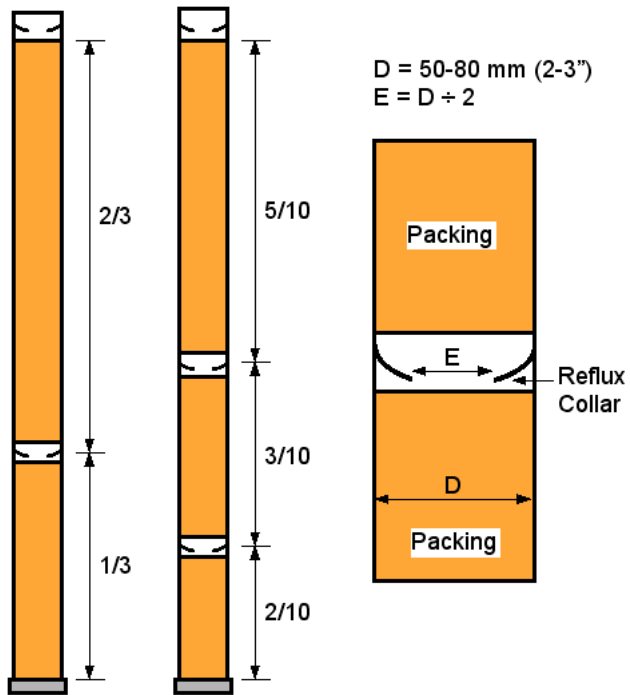

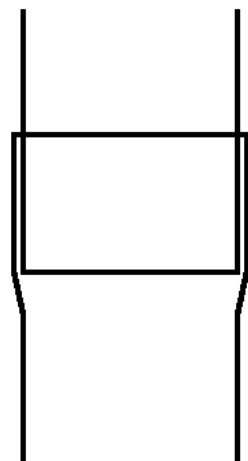
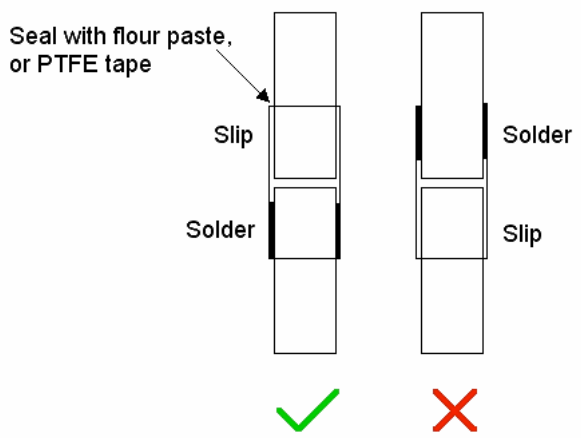
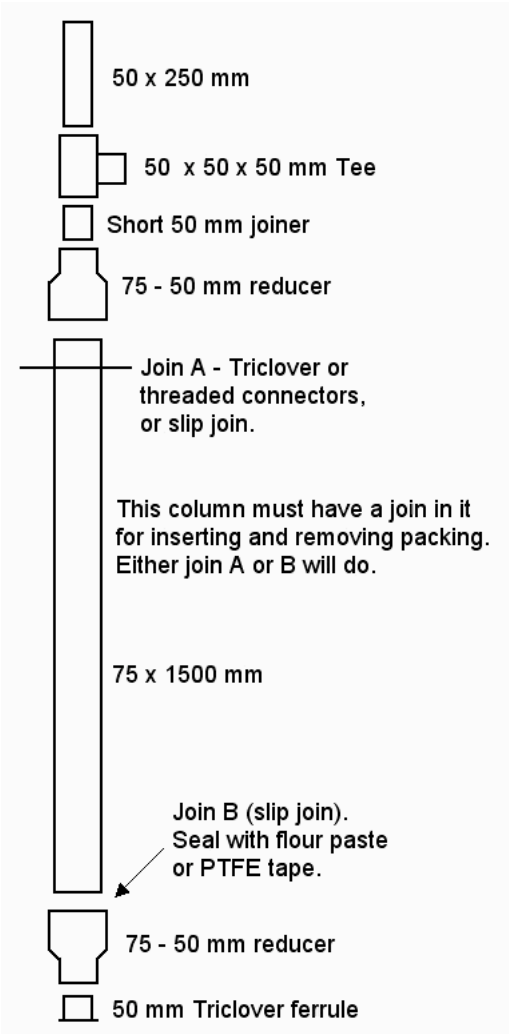

Horizontal Condenser (VM)

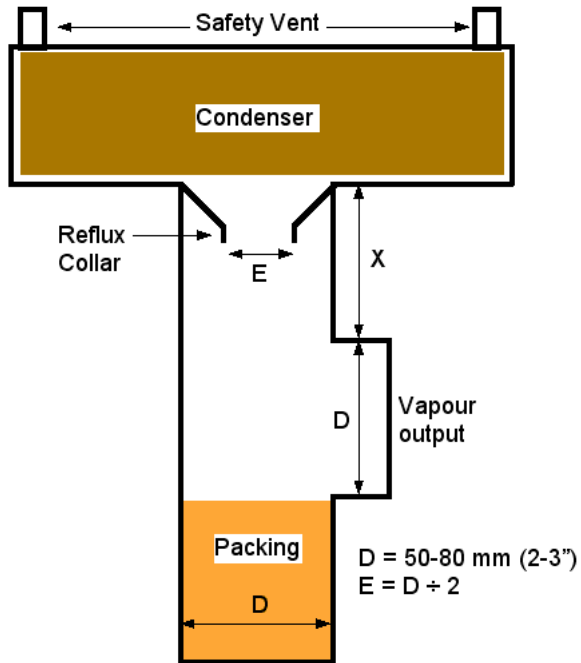

Note the value for  $X$  is not determined. But it shouldn't need to be greater than  $D$ , and might be less.

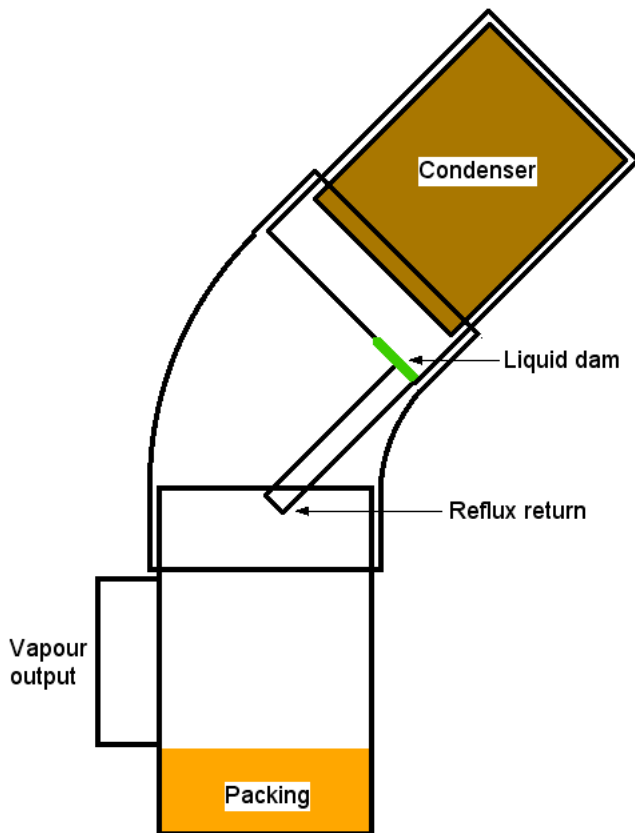

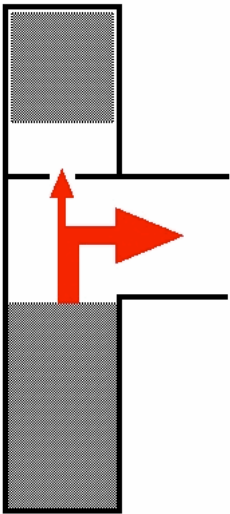
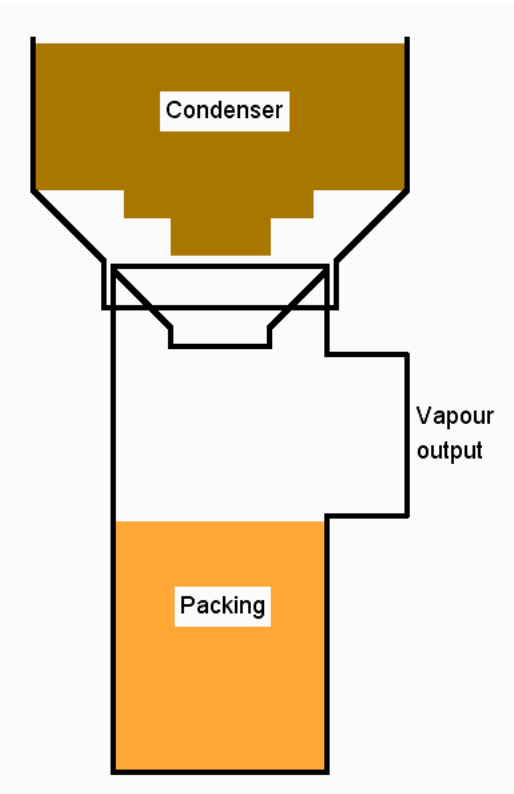



VM Head (restricted)

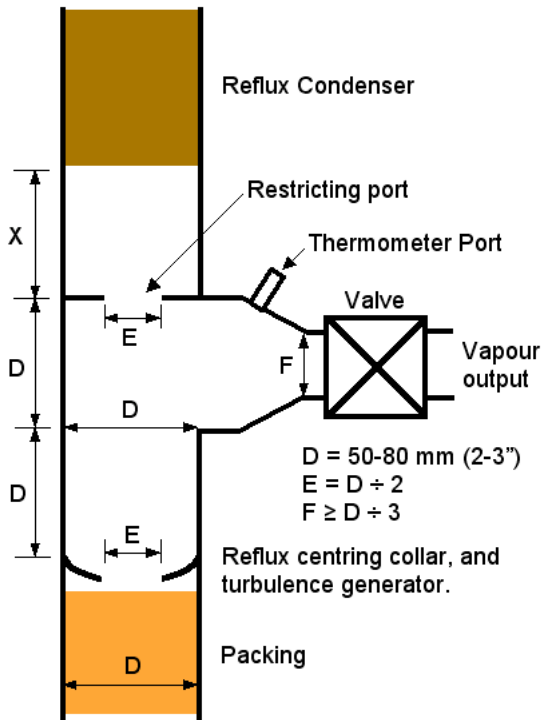

Note the value for X is not determined. But it shouldn't need to be greater than D, and might be less.

Restricted VM  
(internal reflux, drip ring)

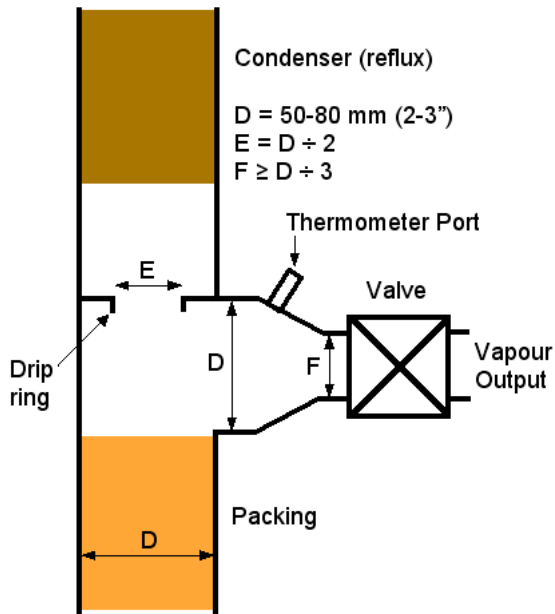

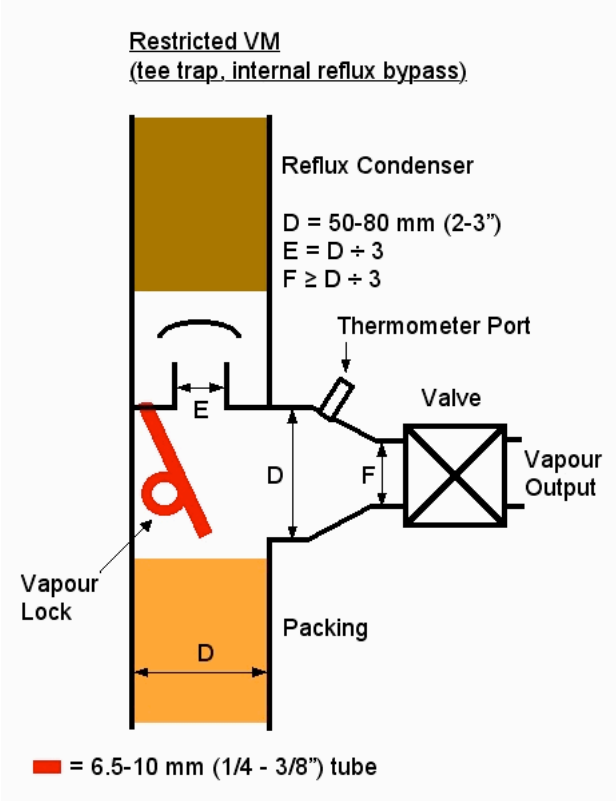
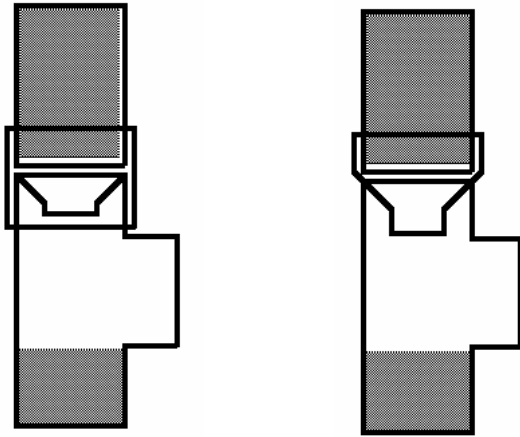

**Restricted VM**  
(tee trap, external reflux bypass,  
internal vapour lock)

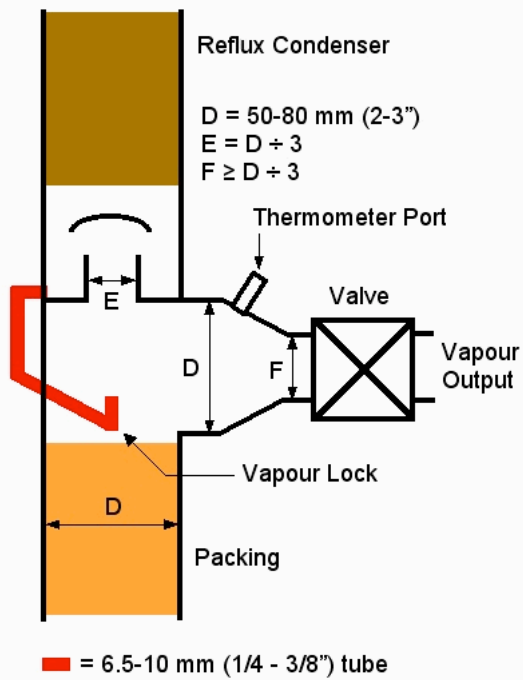

**Restricted VM**  
(tee trap, external reflux bypass,  
external vapour lock)

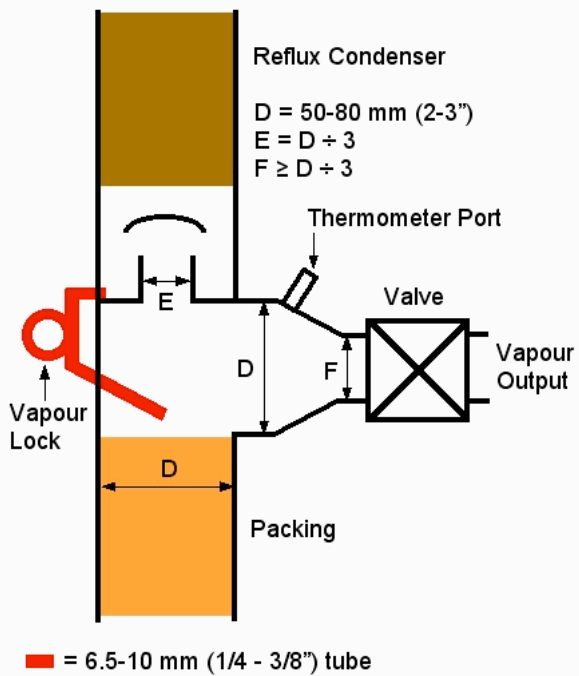

**VM - LM Head  
(tee trap)**

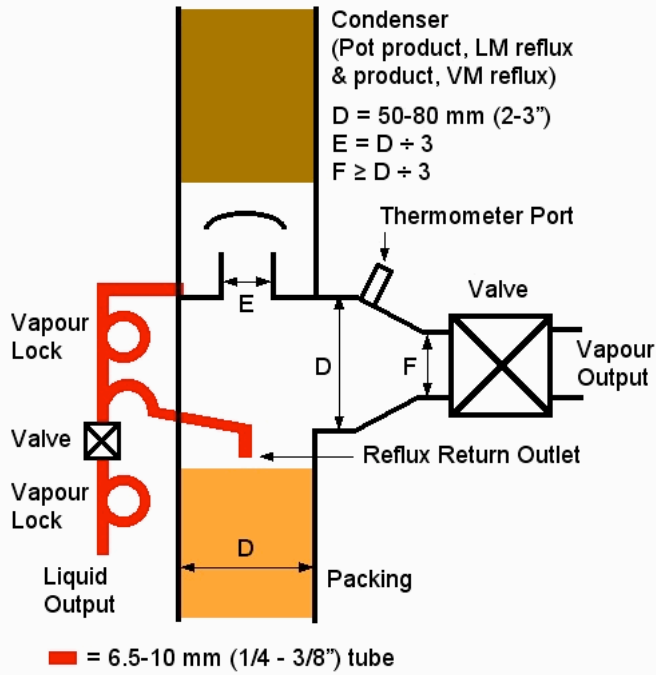

**VM - LM Head  
(tee trap)**

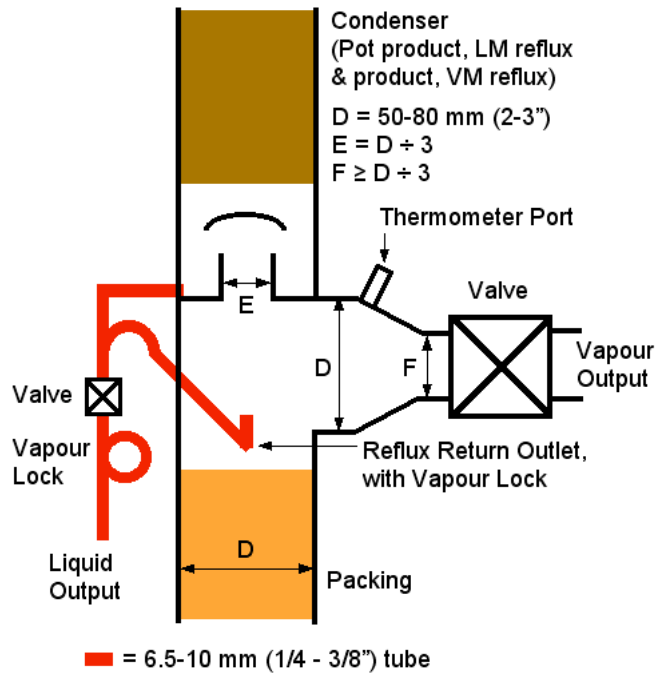

**All-In-One Head  
(tee trap)**

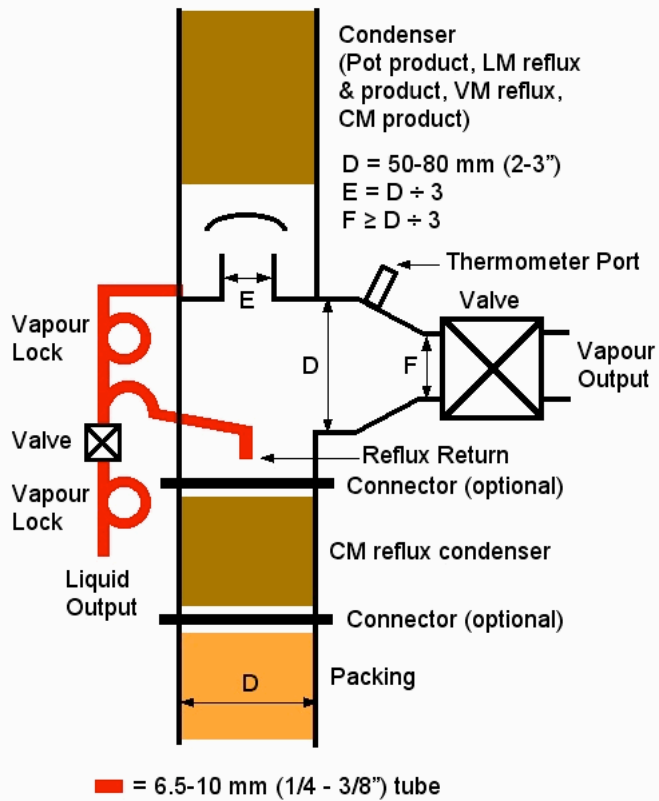

**All-In-One Head  
(tee trap)**

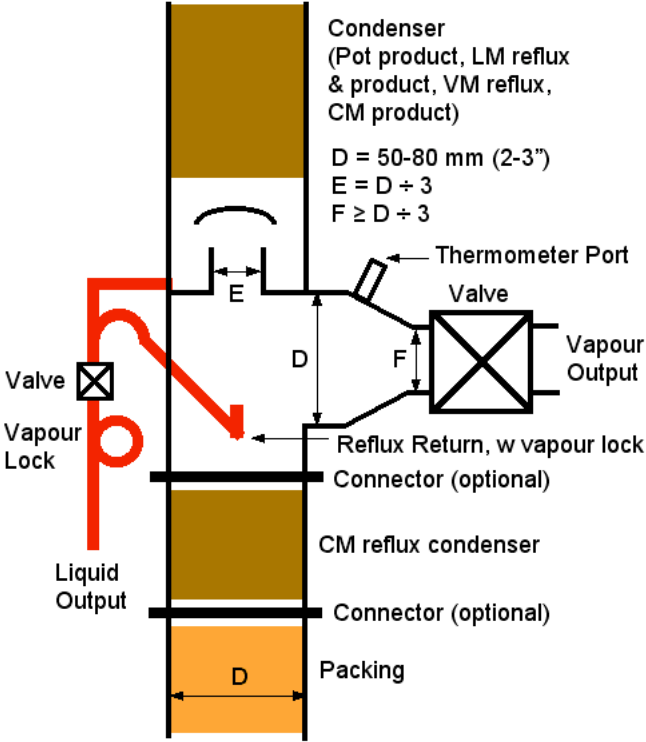

■ = 6.5-10 mm (1/4 - 3/8") tube



**All-in-one Head  
(slanted plate)**

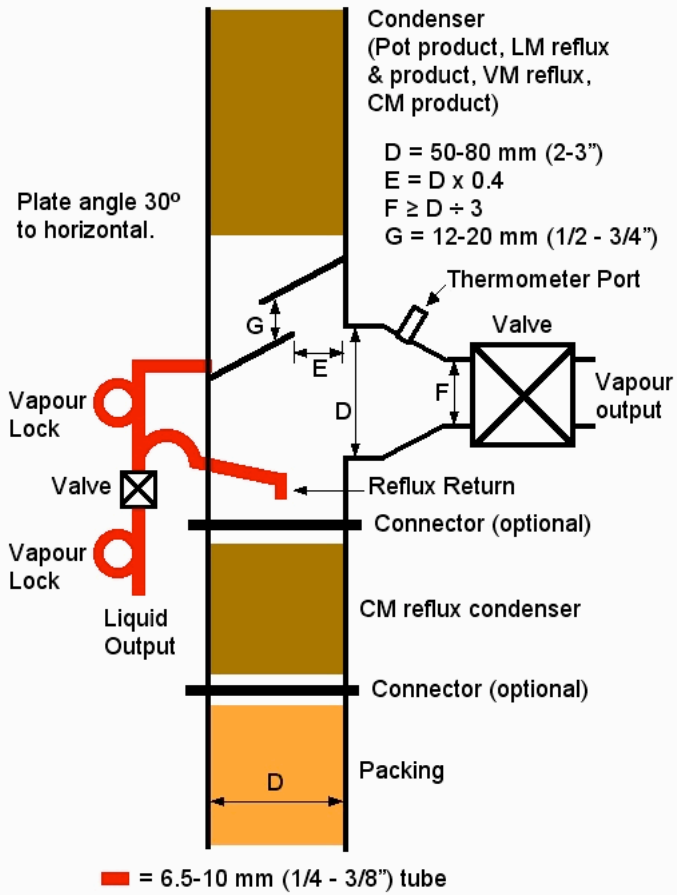

All-in-one Nixon-McCaw VM Head  
(reduced tee, slanted plate)

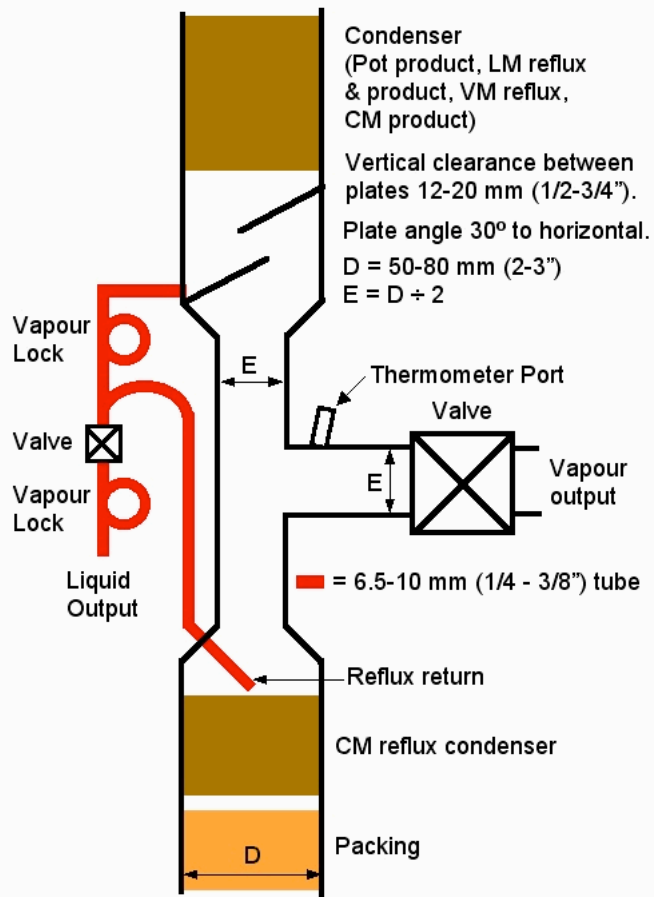



All-in-one Nixon-McCaw VM Head  
(reduced tee, tee trap)

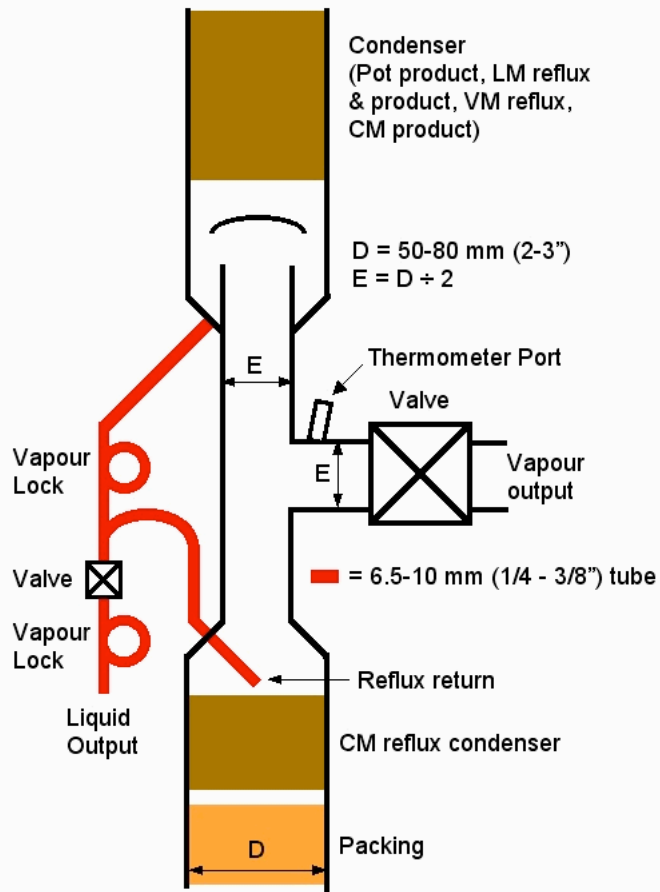

All-in-one Nixon-McCaw VM Head  
(reduced tee, tee trap)

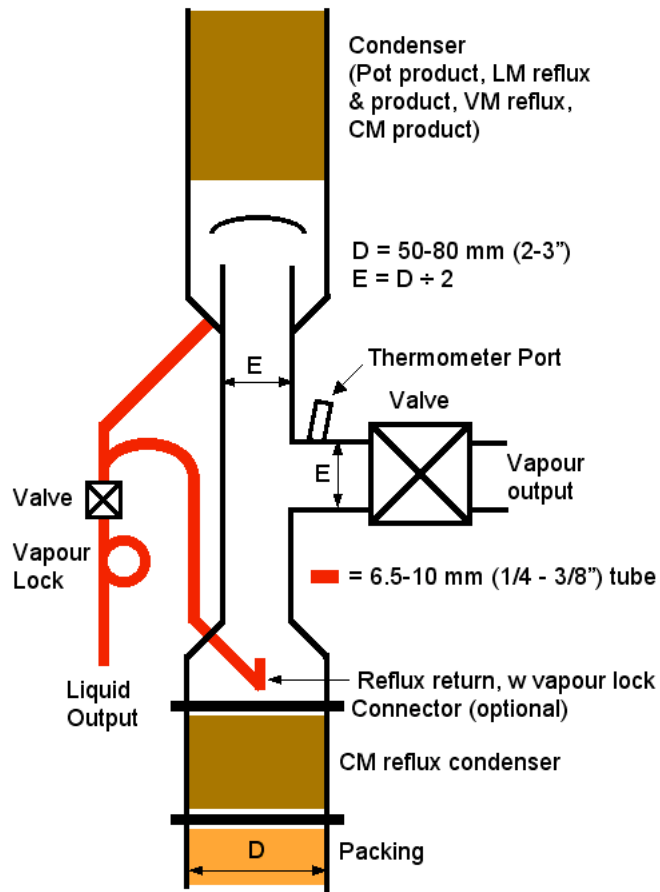

All-in-one Nixon-McCaw VM Head  
(reduced tee, tee trap)

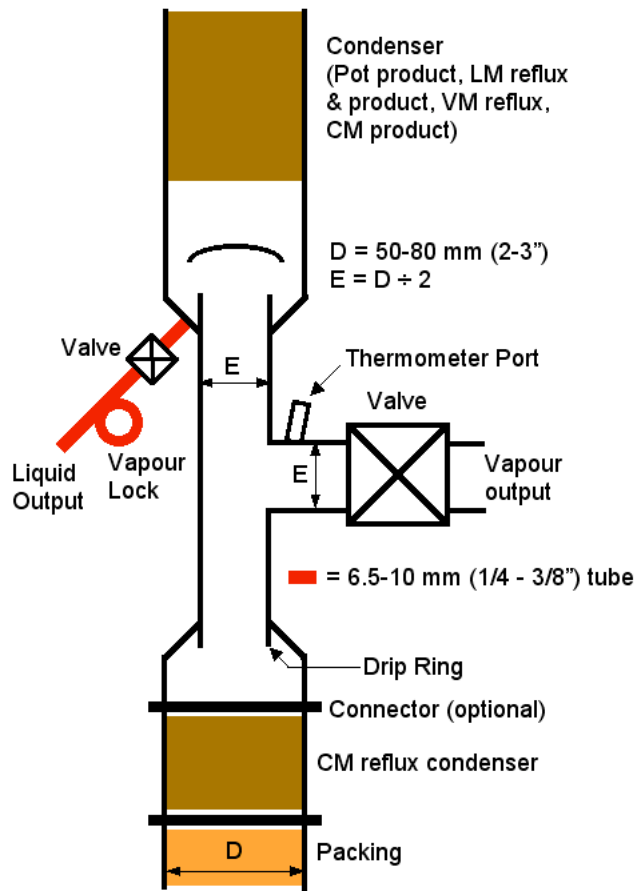

VM Head  
(horizontal tee,  
vertical valve)

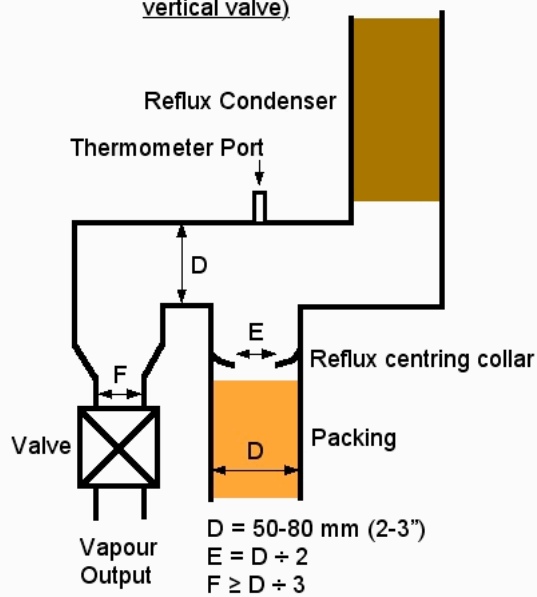

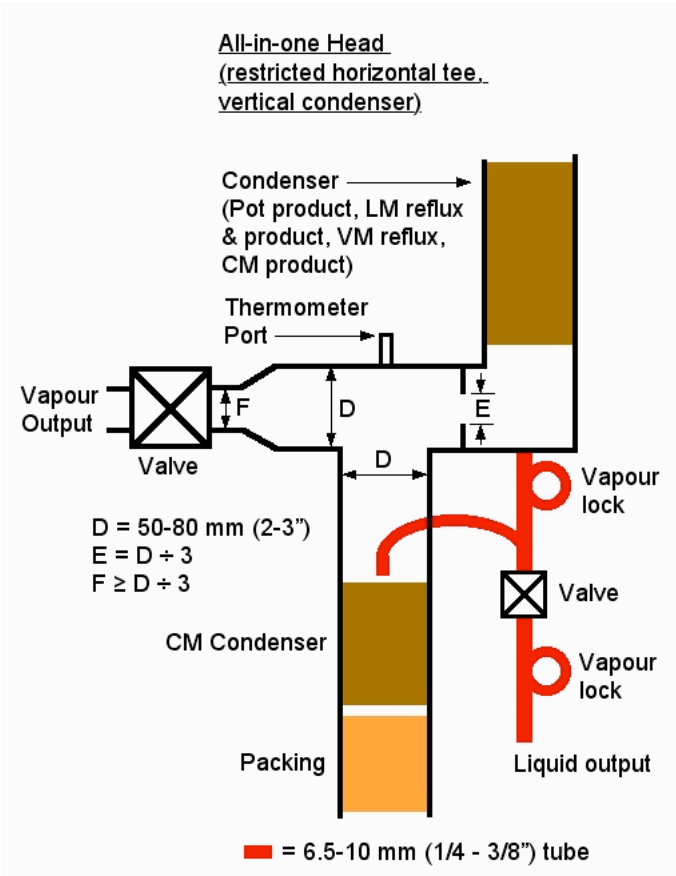
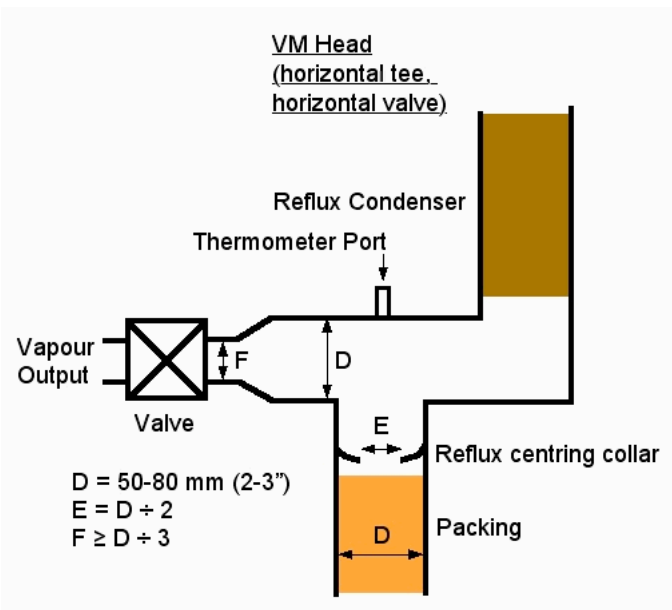

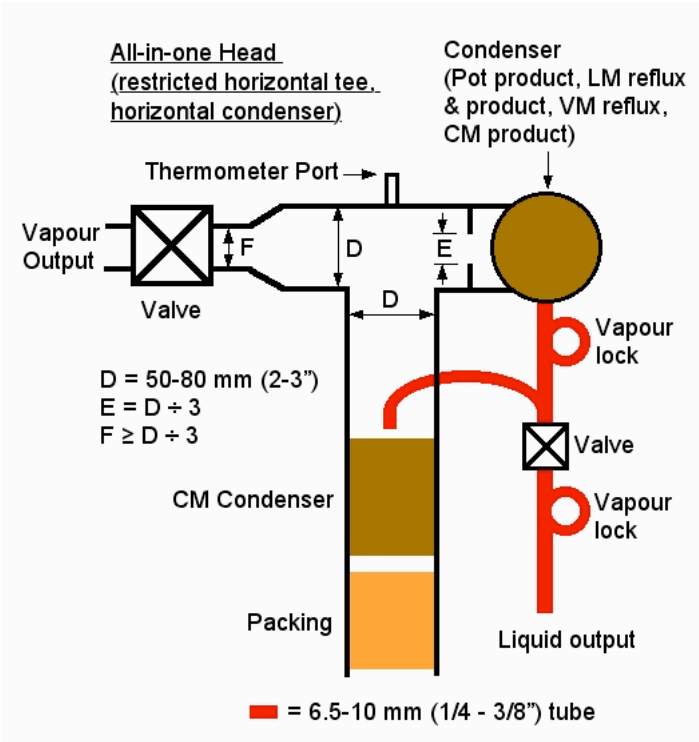



Consider the idea of preferentially directing the vapour flow directly toward the take-off valve in a VM, instead of at the the reflux condenser. If we combine this idea:

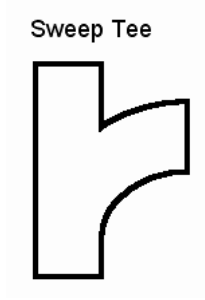

with Manback's vapour flow experiment (results not reported yet), gives us this:

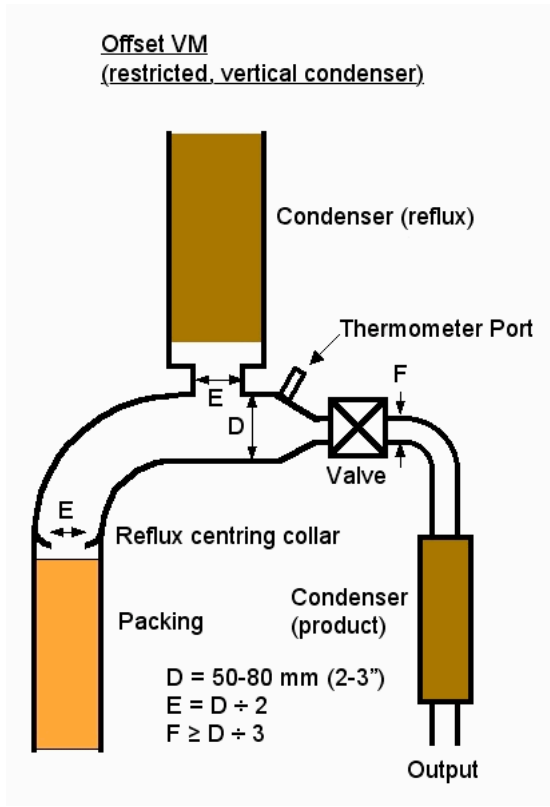

Offset VM  
(restricted, angled condenser)

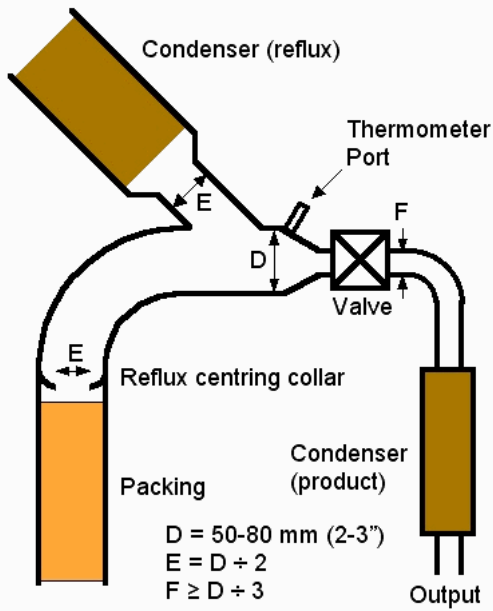

All-in-one Head  
(restricted offset VM, tee trap, vertical condenser)

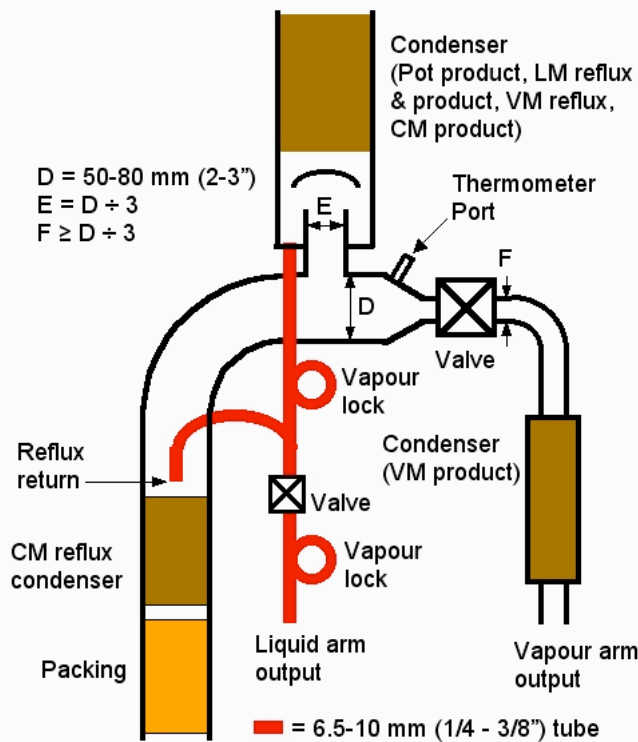

**All-in-one Head**  
 (restricted offset VM, liquid dam,  
 angled condenser)

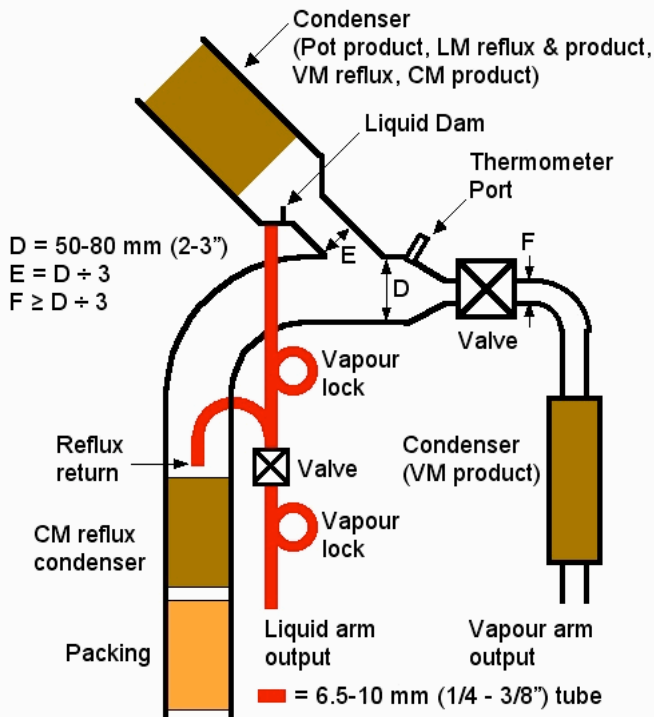

**All-in-one Head**  
 (restricted offset VM,  
 angled horizontal condenser)

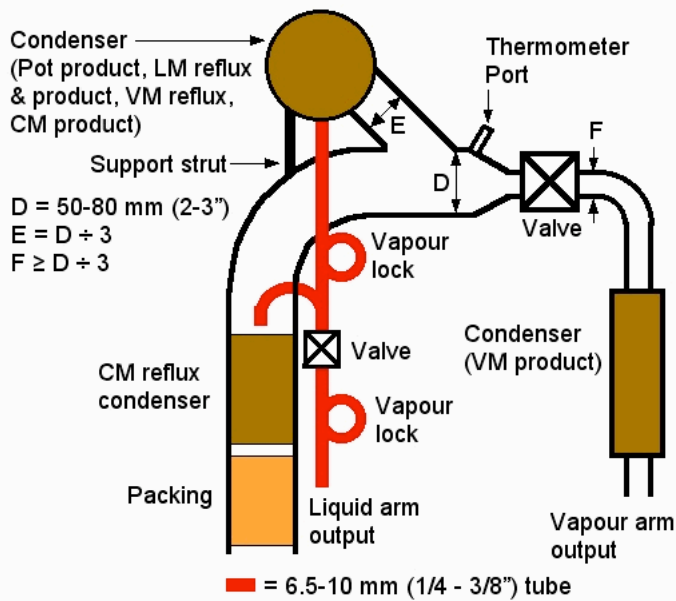



Recirculating pump & reservoir coolant system

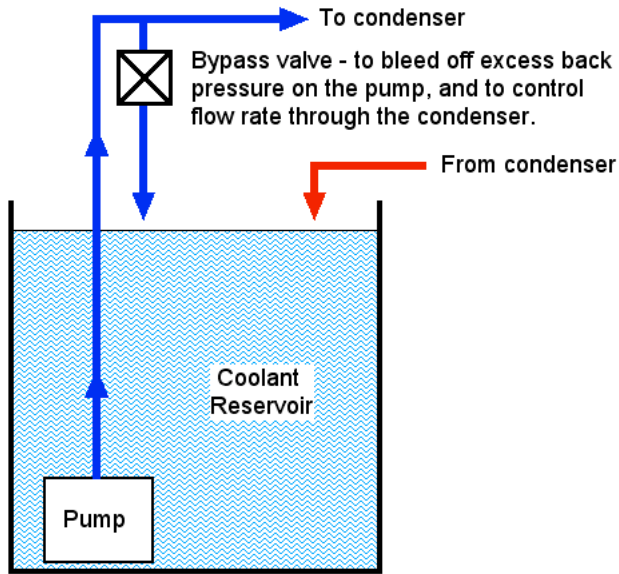

Liquid Management

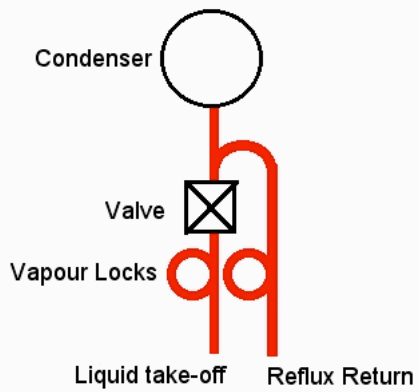

Reverse Liquid Management

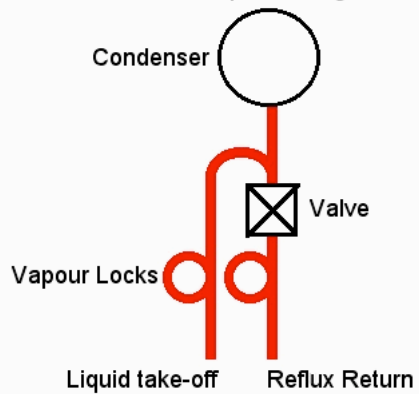

Area of circle =  $\pi r^2$ , where  $r$  is the radius.

Area of ellipse =  $\pi ab$ , where  $a$  is the length of the semi-major axis, and  $b$  of the semi-minor axis.

For a given cross sectional area (CSA), an ellipse has a longer perimeter than a circle. This means an ellipse has 1) more heat exchange surface (perimeter) for a given volume of coolant (CSA), and 2) a shorter maximum distance between the coolant and the exchange surface ( $b < r$ ). Both of which give faster (ie more efficient) heat exchange.

The trade off is that a circular CSA has the lowest internal flow resistance of any cross sectional shape, and altering it to any other shape increases resistance (back pressure), which decreases the maximum coolant flow rate.

However, given that typical coolant flow rates in hobby condenser coils are well below the maximum possible, this is not a practical problem, as long as the degree of flattening is not great.

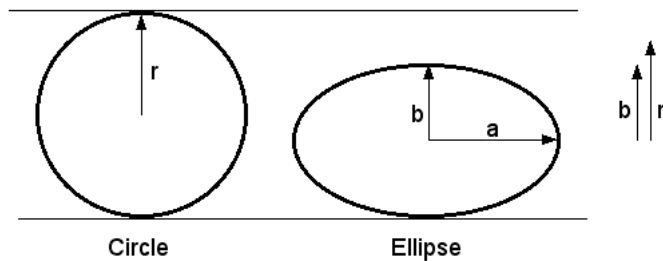

## DPDT (centre-off) Switching Schematic

These wiring diagrams are for the household wiring system in the USA, and don't necessarily work in other wiring systems.

Red and black can be swapped in these diagrams. It gives electrically equivalent circuits.

Ground (earth) the boiler, and the switch box (if it is metal)

NOTE: The neutral wire in the USA is white, not blue.

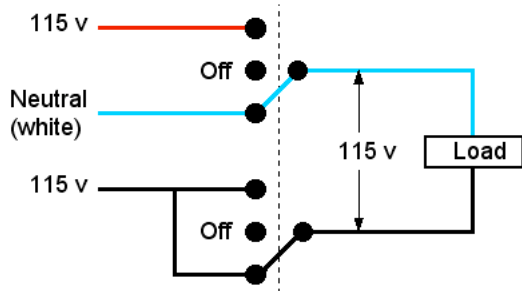
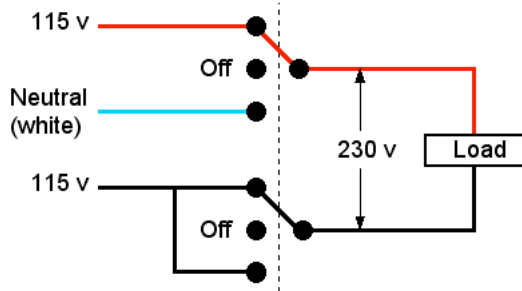

THE END