

## A Step by Step Guide

---



# Building a Home Distillation Apparatus

## Foreword

The pages that follow contain a step-by-step guide to building a relatively sophisticated distillation apparatus from commonly available materials, using simple tools, and at a cost of under \$100 USD.

The information contained on this site is directed at anyone who may want to know more about the subject: students, hobbyists, tinkers, pure water enthusiasts, survivors, the curious, and perhaps even amateur wine and beer makers.



Designing and building this apparatus is the only subject of this manual. You will find that it confines itself solely to those areas. It does not enter into the domains of fermentation, recipes for making mash, beer, wine or any other spirits. These areas are covered in detail in other readily available books and numerous web sites.

The site contains two separate design plans for the stills. And while both can be used for a number of distillation tasks, it should be recognized that their designs have been optimized for the task of separating ethyl alcohol from a water-based mixture.

Having said that, remember that the real purpose of this site is to educate and inform those of you who are interested in this subject. It is not to be construed in any fashion as an encouragement to break the law.

If you believe the law is incorrect, please take the time to contact your representatives in government, cast your vote at the polls, write newsletters to the media, and in general, try to make the changes in a legal and democratic manner.

As a final word, if you decide to build a still like this, you will be on your own. It is distributed **WITHOUT ANY WARRANTY**; without even the implied warranty of **MERCHANTABILITY** or **FITNESS FOR A PARTICULAR PURPOSE**.



# Table of Contents

<b>FOREWORD</b> .....	<b>2</b>
<b>TABLE OF CONTENTS</b> .....	<b>3</b>
<b>INTRODUCTION</b> .....	<b>7</b>
GOVERNMENT REGULATIONS .....	7
<b>WHERE TO START?</b> .....	<b>9</b>
INFORMATION SOURCES.....	9
<b>WHAT KIND OF STILL?</b> .....	<b>12</b>
POT STILLS .....	12
<b>REFLUX STILLS</b> .....	<b>14</b>
OVERVIEW .....	14
<i>Adam's Still</i> .....	15
<i>Corty's Still</i> .....	15
<i>Cellier-Blumenthal Still</i> .....	16
BATCH DISTILLATION .....	17
<b>DISTILLATION PURITY CONSIDERATIONS</b> .....	<b>18</b>
FICTION AND FACT .....	18
MOONSHINE AND DISTILLATE PURITY .....	19
DRUGSTORE MOONSHINE .....	19
WHAT'S IN A PURE SPIRIT .....	20
<b>BOILER SELECTION</b> .....	<b>21</b>
SELECTION CONSIDERATIONS.....	21
STAINLESS STEEL .....	22
STAINLESS STEEL MILK CANS .....	22
STAINLESS STEEL BEER KEGS .....	23
<b>THE TOP END</b> .....	<b>24</b>
OVERVIEW .....	24
WHY TWO DESIGNS? .....	25
<i>Versatility</i> .....	25
<i>Simplicity</i> .....	25
<i>Ease of Construction</i> .....	25
<i>Performance</i> .....	25

## BUILDING A HOME DISTILLATION APPARATUS

<i>Cost</i> .....	25
MAKING THE CHOICE.....	26
<i>Internal Reflux Still</i> .....	26
<i>Valved Reflux Still</i> .....	27
<b>TOOLS AND TECHNIQUES .....</b>	<b>29</b>
TOOL LIST.....	29
CONSTRUCTION OVERVIEW .....	30
SOLDERING THE FITTINGS .....	30
SILVER SOLDERING .....	31
<b>INTERNAL REFLUX CONDENSER.....</b>	<b>33</b>
CONDENSER CONSTRUCTION .....	33
JACKETED CONDENSER.....	34
CONDENSER COOLING FLOW .....	35
CONDENSER JACKET OVERVIEW .....	36
CONDENSER JACKET .....	38
<b>INTERNAL REFLUX TOP END.....</b>	<b>39</b>
COLUMN CONSTRUCTION .....	39
THE COLUMN HEAD.....	39
THE COLUMN BODY.....	40
FINAL TOP END ASSEMBLY .....	40
<b>VALVED REFLUX STILL HEAD .....</b>	<b>42</b>
VALVED REFLUX OVERVIEW.....	42
STILL HEAD CONDENSER.....	42
CONDENSER COIL.....	43
INSTALLING THE COIL .....	43
NEEDLE VALVES .....	44
<b>VALVED REFLUX COLUMN.....</b>	<b>45</b>
COLUMN OVERVIEW .....	45
THE COLUMN HEAD.....	45
COLUMN AND HEAD ASSEMBLY.....	46
COOLING SUPPLY .....	46
FINAL COLUMN ASSEMBLY .....	47
<b>ATTACHING THE COLUMN TO THE BOILER.....</b>	<b>48</b>
STAINLESS STEEL MILK CANS .....	48
FLANGE ADAPTER.....	49
ADAPTING A STAINLESS KEG.....	49
<i>Cutting the Keg</i> .....	50
<i>Anchoring the Cover</i> .....	51
<i>Building the Column Adapter</i> .....	51

**BUILDING A HOME DISTILLATION APPARATUS**

*Fitting The Adapter and Cover* ..... 52  
*Covering the Column End*..... 52  
*Making the gaskets* ..... 53  
*Finishing the Keg Cover* ..... 53

**COLUMN PACKING**..... **54**

PACKING MATERIALS..... 54

**HEATING THE BOILER**..... **57**

ELECTRIC HEATING..... 57  
HEATING WITH GAS ..... 58

**COOLING THE STILL** ..... **59**

OVERVIEW ..... 59  
INTERNAL REFLUX STILL ..... 59  
*Cooling Recirculation* ..... 59  
*Recirculation Tanks*..... 60  
*Submersible Pumps* ..... 60  
VALVED REFLUX STILL ..... 61

**STILL OPERATION** ..... **62**

SAFETY ..... 62  
INITIAL CHECKOUT..... 62  
THE INTERNAL REFLUX STILL ..... 62  
*Shutdown*..... 64  
VALVED REFLUX STILL ..... 65  
*Initial Startup*..... 65  
*Shutdown Procedures*..... 66

**OPTIMIZING STILL OPERATIONS** ..... **67**

TEMPERATURE CONSIDERATIONS..... 67  
PURITY RE-VISITED ..... 70  
FUSEL OILS AND CONGENERS..... 71  
HEADS AND TAILS ..... 71  
REFLUX CONTROL..... 72  
THE INTERNAL REFLUX STILL ..... 72  
THE VALVED REFLUX STILL..... 73

**THE LAST WORDS** ..... **74**

**APPENDIX I – COST SUMMARY**..... **75**

MATERIALS AND COST ..... 75  
VALVED REFLUX STILL TOP END SUMMARY ..... 75  
INTERNAL REFLUX STILL TOP END SUMMARY ..... 76

**APPENDIX II - RESOURCES** ..... **78**  
EXHAUST FLANGES, TUBING BENDERS, GASKET PUNCHES, THREAD-SERT KITS ..... 78  
TOOLS, GAS BURNERS, REGULATORS, PUMPS ..... 78  
STAINLESS STEEL MILKCANS ..... 78



## Introduction

### Chapter

# 1

### Government Regulations

So you're interested in building a still. In the US (and many other countries) I guess you know that doing that is just not the politically correct thing to do. Even if you are just a curious person and simply want to know what's involved, you probably feel some reluctance about discussing the subject outside of your own trusted circles.

Everyone should follow his or her own conscience in these matters. Personally, I believe that some of these laws are so poorly thought out and implemented that they border on being ridiculous.

A case in point. In the US, the government allows an individual to produce wine or beer for personal consumption by using a fermentation process to produce an alcoholic beverage.

It is also perfectly legal in the U.S. for that same individual to build or buy and use a distillation apparatus for either personal or commercial use.

Nevertheless, the government makes it *illegal* for the individual to refine the *legally* produced beer or wine with that apparatus and, in the process, *produce another perfectly legal beverage*.

Without much reflection, it is easy to see that such laws are flawed.

Fortunately, it is not illegal to express these opinions. That freedom also extends to writing about such things as alcohol distillation (legal or not), and the use and manufacture of equipment to accomplish this in the home.

## **BUILDING A HOME DISTILLATION APPARATUS**

So, as long as your conscience allows, at least in the US, you are not doing anything wrong by reading this information and there is also nothing illegal about building a still.

And while it is hoped that the still will be used for legitimate purposes, always keep in mind that if you decide to build and use the still to produce ethyl alcohol then, in the U.S. and many other areas of the world, you will most likely be breaking the law.





Chapter

2

## Where To Start?

### Information Sources



**I**t doesn't take long after making the decision to build a still to recognize that there are a lot of things to be considered. A visit to the library, and some reading about the distillation process is a good place to start.

However, many people find it easier to learn by direct involvement rather than reading, and many others have little access to large libraries. Hopefully, this guide will be of some use to both these groups.

Some might consider starting with the Internet. Initial searches will turn up thousands of hits on the subjects of moonshining, distillation, stills, spirits, whiskey, reflux ratio, unit operations etc.

Unfortunately, there isn't a whole lot of really good information about building a first class personal still out there. Sure, there are lots of commercial distillers, beer and wine equipment suppliers, discussion groups, moonshining stories, book sellers, discussion groups, and lots of chemistry information on the web, but only a couple of quality publications on amateur distillation and still construction. There are some good ones though.

One of the best references to start with is from Gert Strand's company in Sweden. His web site offers the "[Home Distillation Handbook](#)". The book has been translated from Swedish to English and written under the pseudonym of Ola Norrman. It is available on line for small fee in PDF format. The web URL is:

<http://www.partyman.sa/>

The Partyman website is a first class source of liquor essences, fermentation, and fine German instrumentation equipment useful in alcoholic beverage measurements.

Ola Norrman's book takes you step by step through every procedure involved in the process of producing a variety of spirit drinks, including guidance in the construction of an appropriate still.

Another good source can be found in Dr. John Stone's book "[Making Gin and Vodka](#)". It can be ordered at <http://www.gin-vodka.com>. Dr. Stone concentrates on producing pure alcohol spirits (Vodka and Gin), but the book discusses in detail the construction of a multi-stage distillation apparatus, much like a scaled down commercial facility might use. It is very complete in describing every phase of producing and refining alcohol, and provides many first hand insights into this process.

For the more technically inclined, the web surfer should read M.T. Tham's Introduction to Distillation tutorial at:

<http://lorien.ncl.ac.uk/ming/distil/distil0.htm>

For those of you who simply want a still, and not all the work of doing it yourself, you will enjoy the Still Life at <http://stillife.com>, and Ray Toms Moonshine Supplies at <http://moonshine.co.nz/>.

The University at Akron offers an excellent slide presentation of distillation theory at: <http://ull.chemistry.uakron.edu/chemsep/distillation/>

For the engineering students among us, you might find Andrew Sloleys' distillation and petroleum refining homepage a good start. You will find it at: <http://asloley.home.mindspring.com>

Purdue University also has an excellent paper on distillation at: <http://www.agcom.purdue.edu/AgCom/Pubs/AE/AE-117.html>

## BUILDING A HOME DISTILLATION APPARATUS

And finally, for the best about the art, science, and folklore about distilling checkout Tony Ackland's "Home Distillation of Alcohol" at:

[http://www.geocities.com/kiwi\\_distiller](http://www.geocities.com/kiwi_distiller)

These sites and books will give you a good starting background for those things you are about to undertake. Certainly there are many others that may be even more appropriate. But for the most part, these provide an excellent foundation for constructing a high quality apparatus that will deliver quality spirits in a safe manner.

And so, armed with this information, and a bit of common sense, we can begin the task by addressing the most important question.

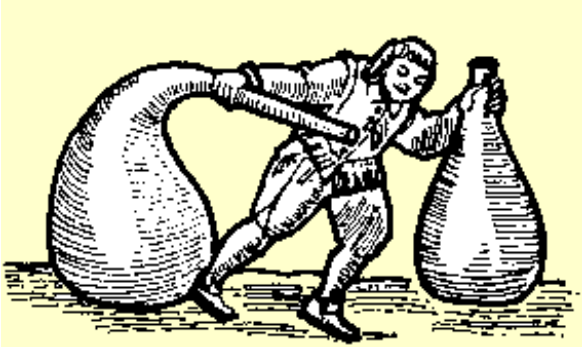

from John French The art of distillation, London 1651.

## What Kind of Still?

### Pot Stills

Pot stills were the earliest kind of stills. They simply had a pot to boil the fermented mash in, and an output tube that passed through something cooler (air or water etc.) which condensed the vapors coming from the pot.



The copper pot stills like the ones shown on the left are reputed to have been in use for over 500 years to make some of the finest Irish Whiskey in the world. While the pot still is enormously inefficient, it is uniquely simple and easily adapted for home distillation of everything from essences to whiskey and moonshine.

Little has really changed in the design of the pot stills over the last 2000 years. You won't find much difference between the moonshine still shown below and the alembic pots used years in Egyptian times to make perfumes.



From the John C. and Olive Campell Collection  
Southern Historical Collection, University of North Carolina

The problem with pot stills is that they don't do a good job at separating out exactly what you want to distill as output. They are usually used to separate compounds whose boiling points differ by about 100° C. When beer is distilled, lots of things come out, some good, some bad. And because there are no fine controls on this kind of still, the output contains a lot of impurities.

Nevertheless, after each distillation, you always get a better output from that which you started with. So each time you re-distill the output in a pot still, it will come out a bit purer. But you lose a little each time you re-distill. To make it really pure, you have to distill it so many times that you'll end up with almost nothing left.

Because each re-distillation requires a completely new setup, it takes a lot longer to produce a reasonably pure finished product using pot stills. I'm told the finest Irish distilleries still use pot stills to make their whiskey. They take great pride in the fact that they triple distill the whiskey. The demand for this product was so great, that they built huge pot stills, some holding over 30,000 imperial gallons of beer.

In more modern times though, these huge pot stills could not provide nearly enough distilling capacity to keep up with the demand. And for that reason most of the distilled spirits today are produced with reflux stills that operate on a continuous basis.

So, while it is tempting to take the easy way out and build a simple pot still, it really wouldn't meet our goal of producing the very purest spirits, in the most efficient manner. To reach that goal you'll have to think about a reflux still.



**Chapter**

**4**

## Reflux Stills

The pot still was the only distillation method known for almost 2000 years. However, that all changed with the introduction of the reflux column during the late 19<sup>th</sup> century. That invention revolutionized the production of many valuable petroleum and chemical products that we commonly use today.

### Overview

The reflux still differs from a pot still in that it employs a column fitted with internal trays or packing to provide a large surface area inside. This allows the distillate vapors from a boiler to rise up the column to the top where the vapors are condensed. The condensed liquid is then allowed to run back down through the rising vapors. As the condensed liquid cascades back down through the trays or packing, it becomes enriched by the rising vapors in the column. As the descending liquid passes down the column toward the boiler, a point is reached where the temperatures become hot enough that the liquid boils again and the vapors again rise up the column. This process is called a reflux cycle.

As this cycle continues, the mixture inside the tower is effectively re-distilled many times.

The reflux still is not a single invention that just happened after almost 2000 years of pot still use. It happened by a rapid series of developments all within about a 100 year span of history.

It all started with Edward Adam.



**Adam's Still**

Edward Adam introduced an industrial scale still in 1801 that featured two intermediate tanks between the boiler and the final condenser.

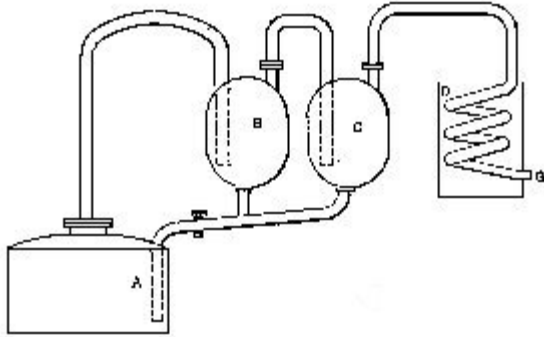

Adam's Still.

The still also provided controls that allowed portions of the distillate from both tanks to be re-circulated back into the boiler for re-distillation. That is a fundamental process involved in all modern reflux distillation operations.

There were some problems with this still though, mainly because of the difficulty in controlling the temperature of the doubling vessels. Also the bubbling of vapors through the liquor created too high a pressure in the tanks. Nevertheless, the Adam still was quite successful, and provided great profit to the inventor for many years.

Naturally, this made it widely imitated, and many improvements were incorporated into the basic design very quickly.

Perhaps the most well known of these designs was Corty's Patent Simplified Distilling Apparatus which is shown below.

**Corty's Still**

Corty's apparatus incorporated the external doubler vessels of the Adams still into a column structure located on the still head. The doubler tanks now took the form of three water-cooled plates built into the column.

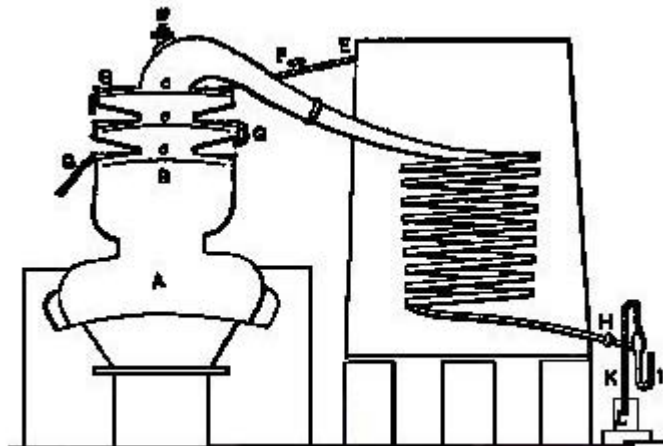

Corty's Simplified Distilling Apparatus.

## BUILDING A HOME DISTILLATION APPARATUS

These plates are not unlike those found in modern reflux distillation columns, and served as internal condensing surfaces. This allowed the distillate to cascade down inside the still and mix with the rising vapors from the boiler. With this arrangement, the purest distillate formed on the top plate before being drawn off for collection.

Another feature of this still was that it claimed to conserve fuel because it operated under a partial vacuum created by the distillate flow through the final condenser which was sealed from the air. Perhaps this might have been the first practical use of a partial vacuum distillation.

These two early industrial era stills were important steps in the advancement of distillation technology primarily because they incorporated the concept of having part of the distillate returned to the heating source for re-distillation, and they also provided a means to allow the boiler vapors to percolate through the partially condensed alcohol as it was returning to the boiler.

That flow is called reflux. It is the hallmark of the still and it produces a much purer

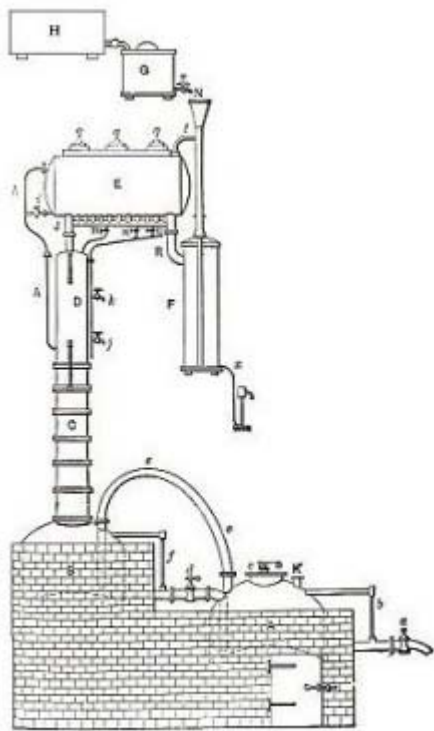

product with a single distillation run than the pot still. The next most important development came with the Cellier-Blumenthal still.

### Cellier-Blumenthal Still

This still incorporated almost all of the general principles of the stills currently in use today. Its most important feature is that it was designed to operate continuously. That is to say that once in operation, the material to be distilled is entered continuously at one part of the apparatus, and an appropriate amount of distillate is recovered continuously as output. The continuous operation concept provided an enormous improvement in both time and energy costs over previous still designs.

The still also incorporated an overhead condenser with a reflux holding tank. This device allowed the distillate to be collected there and then split into a reflux stream going

back to the column or another stream going to the collection of the output.

Perhaps more importantly, the design allowed more rigorous scientific examination with the principles of Thermodynamics developed during that era.



### **Batch Distillation**

While continuous distillation methods provide the volume output demanded by industry, the practice is not well suited to our interests. We just want to separate on occasion, a single compound from a liquid mixture with a small scale still. That's called batch distillation.

Batch distillation stills operate in a completely different way than do the continuous operation stills, and much of the data derived from the theoretical models used to optimize a still running under equilibrium are not directly applicable to the design of a batch still.

Fortunately, the reflux column can be used with either batch or continuous distillation operations, and it can be scaled up or down to meet either industrial or home distillation needs.

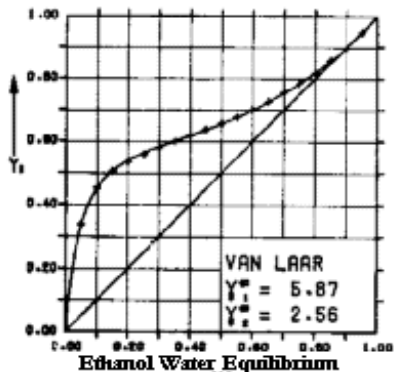

Chapter  
5

## Distillation Purity Considerations

### Fiction and Fact

Before we get into the details of what makes a distillate pure, it's important to address some myths and tall tales about people being poisoned or going blind as a result of drinking improperly distilled alcohol.

Always remember that distillation is simply a separation and purification process.

*Neither the fermentation of sugars contained in the mash nor the distillation of the alcohol resulting from that process can produce any toxic amounts of poisons. That includes the often-cited methanol, and it doesn't matter how well the still is built, or how poorly the distillation itself is conducted.*

Most instances of methanol poisoning attributed to improper distillation resulted from people drinking denatured alcohol.

Denatured alcohol arises as an attempt on the government's part, to preserve tax revenues applied to alcoholic beverages. To insure this, laws were passed in the U.S. mandating that all ethyl alcohol not produced for beverages be deliberately poisoned to render it unfit for drinking. The process is called denaturing. A common denaturing practice is to add methyl alcohol, a poison, or other noxious ingredients to the alcohol and render it undrinkable.

The government does not tax the production of denatured ethyl alcohol, but closely controls how it is done.

Unfortunately, that only makes denatured alcohol cheap. It does not prevent some from drinking it, or using it to fortify other beverages, or worse, trying to purify it by distillation.

That is not to say the government is ruthless and insensitive to the tragedy that results from the deliberate misuse of these regulations. The illegal moonshine operations have a terrible history in this regard.

### ***Moonshine and Distillate Purity***

To cite an example, during the American prohibition period, huge quantities of beverage alcohol were produced on a daily basis by hundreds of thousands of small (many individual) distilleries, using equipment that was unbelievably crude, and which was operated under filthy conditions of sanitation. In the interest of high production, many of these small moonshine operations would add all sorts of noxious chemicals to improve the taste, appearance and proof of the spirit and thereby compensate for the hasty methods used in production. Common lye, a corrosive alkali, was often used to disguise the proof of the spirits, and Clorox®, paint thinner, rubbing alcohol, Sterno®, and formaldehyde were used to mask the unpalatable fusel oils that were often present. Sometimes fertilizer and manure were added to the mash to speed fermentation.

As bad as this may seem, the legitimate commercial market had its share of bad news in this department too.

### ***Drugstore Moonshine***

In another epidemic, during this same era, it was estimated between 35,000 and 50,000 people were afflicted by a "Jake Leg" malady that caused paralysis of the victim's legs and feet. The cause was traced to a chemical called triorthocreysl phosphate. This chemical was an ingredient of a popular drugstore over the counter tonic. In reality the tonic was a tincture of Jamaica Ginger. The "Jake" was about 90% alcohol. Wood alcohol (methanol) was also added to it to mask the strong ginger taste.

The effect was predictable, but it was legal, and there were high profits to be made. Some things never change, and that's why we are so concerned with the purity of the spirits that are produced by the stills in this manual.

What's in a Pure Spirit

Distillate purity is always directly related to the contents of the mash. A chemical analysis of the typical distillate (excluding water and ethyl alcohol) produced when a batch of molasses based beer breaks down as follows:

<b>Organic acids</b>	<b>0.152 %</b>
<b>Esters</b>	<b>0.071</b>
<b>Aldehydes</b>	<b>0.015</b>
<b>Furfurol</b>	<b>0.00019</b>
<b>Higher Alcohols</b>	<b>0.412</b>
<b>Nitrogenous Substances</b>	<b>0.0006</b>

Notice that the total impurities (excluding water) typically amount to less than one percent, there is no methanol present, and there are no toxic amounts of any component.

Under these circumstances then, the major measure of purity becomes how much water is contained in the distillate. This is best determined with a simple hydrometer.

But measuring the purity of ethanol with a hydrometer has its limitations. Unfortunately it cannot measure those minor amounts of other impurities in the distillate that are easily detected by the human senses of taste and odor.

A great deal of effort must go into producing a satisfactory tasting product. And while producing a very pure product will protect you from the maladies discussed above, it does not necessarily mean that it will taste good.



## Boiler Selection

### Selection Considerations

The boiler is the workhorse of any batch still, and it needs to be rugged because it takes the most abuse of any other component. It is sometimes subjected to open flame, corrosive beer, and heavy charges. For those reasons selection of the materials and capacity for this component is very important.

Various sources have suggested that a good boiler can be constructed by converting used restaurant pots, stainless steel wash pails, bakers dough pans, used soda and beer kegs, old swimming pool filters and a few other such things into a boiler. These items are all good candidates for the purpose, but converting them into a boiler for a reflux column is not always easy.

Sometimes these vessels require considerable modification and specialized welding in order to provide proper connections to the column and a way to disassemble the apparatus for cleaning.

You should always give considerable thought to what fabrication will be required before you make your selection of boilers. It is very important that you be able to easily separate the boiler and column sections for cleaning.

Also, construction is made a lot easier if the boiling vessel has a tightly fitting, removable top, but you must insure that any rubber or plastic gaskets will not impart an off taste to the spirits when subjected to the boiling vapors.

## *Stainless Steel*

Stainless steel is an ideal boiler material because it cleans easily, looks nice, and has great resistance to the effects of boiling corrosive liquids.

On the other hand, stainless steel is very difficult for the average home handyman to work with. Moreover, there are very few ready-made fittings available for joining the parts. It is very expensive, and it is difficult to find a supplier willing to deal in small quantities with this material.

## *Stainless Steel Milk Cans*



Some time ago, when building the first still for this guide, the vessel that I found most suitable for this purpose was a used stainless steel milk can. At that time they were commonly available in most rural dairy farming regions of the U.S.A. for about \$30.00 USD.

The nice thing about them, other than availability, was that the flat top made it easy to attach the column. They hold about 10 U.S. gallons, have a removable top, and were easy to move about because of the nice handles.

Physically, they have their own beauty and they shine like a silver chalice. You can actually grow to love the art in this vessel.

However times have changed since then, and now because of the diminishing availability of these stainless steel milk containers, and their increasing cost, you might want to consider other alternatives.

Nevertheless, they make a fine boiler.

Their biggest advantage for this purpose is the removable, watertight cover. This allows the boiler to be easily charged, and easily cleaned. Perhaps more importantly, the flat cover top makes it quite easy to attach the reflux column to it using either TIG welding, Silver or Brass brazing, or a bolt-on flange.

If you'd like to consider using this type of boiler, Appendix II contains a list of sources within the U.S.A. that currently deal in these containers. New ones range in price from about \$130 - \$190 USD. Used or rebuilt vessels range between \$50 and \$100.

### *Stainless Steel Beer Kegs*

Stainless steel beer kegs also provide an excellent alternative to the milk can discussed above, and are much more available. The major drawback is that, without modification, they cannot easily be cleaned, charged, or inspected internally.



In the U.S. beer kegs are commonly available in half keg (15.5 gallon) and quarter keg (8.25 gallons) capacities. These sizes are well suited to handling either single or double batches of wash.

For home distillation, the most practical batches consist of about 25 liters (6.6 US gallons) of wash. The fermentation vessels and prepared packages of yeast for these size batches are readily available at most brew shops.

And while both keg sizes will suffice for the task, there are a number of advantages in using the half keg size.

The first is a matter of stability. The stills described in this manual contain columns that stand almost three feet over the top of the boiler. That allows them to be easily tipped over when a small base is used. Also the quarter keg size is made with an eggshell shape. This also makes the base even less stable.

Secondly, the quarter keg has a smaller diameter, and less free space over the liquid when filled with a 25 liter charge. Both the small diameter and free space above the liquid surface can cause instabilities in the vapor flow up the column during operation. Also, the quarter keg size has no convenient handle grips with which the keg can be easily moved about.

Finally, the half keg size has built in handles in the rim and allows a double batch to be processed in a single run. In some circles this is considered an overwhelming advantage, particularly when a single batch of beer weighs almost 50 pounds.

## The Top End

### Overview

The top end of the distillation apparatus is the most important part of the still. It consists of a reflux column, one or more condensing elements, and a mechanism to control the amount of distillate returned to the column as reflux.

The design and construction of the top end will ultimately determine the measure of the still's capability. In this guide you there are two different top end designs presented.



The one on the left provides the reflux control by regulation of cooling tubes within the column. This model will be referred to as the Internal Reflux model.

The still on the right has valves to on the still head to regulate the reflux. This still will subsequently be referred to in this guide as the Valved Reflux model.

Each design has its own advantages and detractions. So we need to look into that before we go on.





### **Why Two Designs?**

At first glance, it may seem like an unnecessary complication to have two quite different still heads for this apparatus. Especially when they both produce the same 95% pure ethanol distillate. So I guess it's time to look at what kind of things might lead us to even considering two designs.

### **Versatility**

One of the issues is versatility. That is to say that each of us has a different reason for reading about home distillation. To cite a few examples:

- Some may be interested in producing pure water for either emergency or regular use.
- Others may be interested in producing aromatics and essential oils.
- Non-commercial vintners and winemakers may be concerned with providing neutral spirits for fortification of their products.
- Those who would make brandy and Cognac need to preserve the aroma and body of their spirit.
- The Vodka and Gin advocates seek absolute purity in the spirit.
- Some prefer moonshine.

The list goes on... But it becomes clear that to serve all these purposes, the apparatus must be able to operate as either a pot or a reflux still.

### **Simplicity**

Running a pot still is almost as easy as boiling water. Pot stills don't care much about heat control, regulating cooling, or adjusting the reflux flow.

### **Ease of Construction**

There's also a lot to be said for how easy it might be to build, and how easy it may be to get the right materials in the first place.

### **Performance**

Regardless of the type of still you might use for a task, it should measure up to your expectations, and do the job well.

### **Cost**

Cost is always a consideration. Generally, it must be balanced against all of the factors listed above.

### **Making the Choice**

What it all comes down to is that you have to select the right top end to match what you want to do with consideration of these issues. To do it right, you need to know the limits of each of the two top end designs.

### **Internal Reflux Still**

While primarily designed as a reflux still, this still can also be run as a pot still by removing the column packing.

But even when the packing is removed, the distilling vapors must pass over the upper and lower cooling tubes intrinsic to this design. These tubes supply the final condenser, and cannot be disabled without extensive re-plumbing of the still.

This will undoubtedly provide some small degree of reflux, and perhaps a slightly purer distillate, but both of these effects may not be suitable for the task at hand. The tubes will also reduce the rate of distillation somewhat when the apparatus is configured as a pot still because they present an obstruction of the vapor flow up the column.

In terms of operational simplicity, this type of still is more difficult to work with than the valved reflux still. The underlying reasons for this is that controlling the reflux flow is done indirectly – by adjusting the cooling flow. The adjustment is difficult because you cannot easily judge how much coolant is really flowing by turning the faucet valve and you cannot see how that adjustment impacted the actual reflux flow.

The control adjustments become even more difficult when used in conjunction with a holding tank (discussed later) to buffer the cooling water. In that situation, the cooling water continually rises in temperature, and requires a compensating increase in the coolant flow to keep the reflux and output distillate flows constant.

The top end for this still is also a little more difficult to construct than the valved reflux still. There are more joints to be soldered, and there is some difficult drilling involved that is not needed with the valved model.

From a cost/performance point of view, preliminary results seem to indicate that both produce comparable distillate purity, but at the time of this writing, the optimization testing of the valved reflux still is still underway and the data is not yet complete enough to make a determination of the maximum practical distillation rates.

### *Valved Reflux Still*

Like the internal reflux model, this still is also designed to operate as a pot still when the packing is removed from the column. However, in this design there are no cooling tubes to obstruct the column vapor flow, and you can adjust the reflux flow can in order to suit the task with a simple valve adjustment.

That makes this model quite a bit more versatile in this regard than the internal reflux model.

Operationally, this model is easier to handle than the internal reflux model as well. The reason is that most of the control of the distillation run is managed by the reflux and output control valves. These valves greatly simplify cooling flow adjustments during the course of a distillation.

The still is also easier to construct. There are fewer sizes of tubing involved, fewer solder joints to make, and much less drilling involved with this model.

On a cost/performance basis, preliminary results seem to indicate that both stills produce comparable distillate purity, but at the time of this writing, the optimization testing of the valved reflux still is still underway and the data is not yet complete enough to make a determination of the maximum practical distillation rates.

So it's now up to you to decide which top end best suits your needs. But whatever your choice, some thought has to be given to the materials you'll deal with in this project. That's in the next section.

## Material Selection

It seems natural that a stainless steel boiler should have a stainless steel top end. That would not only look nice but it is also easy to clean, rustproof, and extremely durable.



Here's a picture of what an all stainless steel Internal Reflux still looks like. This beautiful example was built by Ian Pilcher, a master Australian craftsman, and serious distiller.

But for the rest of us less talented people, dairy or medical grade stainless tubing and fittings are not easy to find and the parts are horrendously expensive. A small 1/2" stainless coupling can cost as much as \$36.00 USD. Regardless of these costs, you will find most of the suppliers will not want to deal with you on such small orders.

The automotive supply stores offer stainless steel T409 automotive exhaust pipe. And while it is less expensive (about \$10.00/Foot), it takes a lot of polishing to make it look good. And because there are limited fittings available, this kind of tubing needs extensive welding to fabricate it.

Glass stills are great in the lab. But they are too small and too expensive for handling a 25 or 50 liter batch, and too fragile for rough use.

I've heard of some stills, which were made with ABS or PVC plastic piping. These materials are not recommended for this type of still. They are not suitable for containing vapors at high temperatures, and the hot alcohol in the column may leech out dangerous chemicals during the distillation.

So what you build the top end with will probably come down to what is available where you live. If you live in the US, and you want to build a still at home, then most likely, plain old copper tubing will be your best choice.

It's easy to cut, silver braze, and solder. There are an endless number of standard fittings available at plumbing supply distributors, a wide variety of tubing sizes, it is quite inexpensive (around \$1.00-\$3.00/ft.) and it really looks beautiful when polished. Some even say it gives character to the flavor of the spirits too.



## Tools and Techniques

One of the primary goals of designing the stills discussed in this manual was to ensure that a typical do it yourself kind of person, using only common hand tools, can do the job. As with any project, there are basic tools to have and then there are those tools that make the job much easier. Both are listed below:

### Tool List

Basic Tools	Nice to Have
Hacksaw	Plumbers Pipe Cutters
Measuring Tape	
Electric Drill and Drill Bits	Drill Press or Drill Guide***
Propane or Mapp® Gas Hand Torch	Plumbers Torch or Brazing Torch
Saber Saw with Metal Cutting Blades	Reciprocating Saw & Blades
Utility Knife	Gasket Cutter Punch Set
4" Bench Vice	
Cloth Backed Sandpaper/Steel Wool	
Lead Free Solder – Silver Solder	
Round & Flat Files	Die Grinder
	¼" Tubing Bender**
	Thread Set Rivets & Hand Setter*
	Metal Hole Saws

\* Not needed for Milk Can Boiler

\*\* Not needed for Internal Reflux Top End

\*\*\* Not needed for Valved Reflux Top End

### **Construction Overview**

Overall, the construction of either still is quite straightforward. First the top end tubing components should be cut to length.

Then, if you're building the Internal Reflux model, the condenser shell caps should be drilled. All the top end parts should then be assembled with their fittings to check the fit. Finally, the column should be drilled to match and fit the upper and lower cooling tubes that supply coolant to the condenser shell.

The Valved Reflux model is simpler to build in that the condenser shell end caps and the column does not require drilling and solder fitting.

It's important to dry fit all the parts together before soldering.

When all the dry fitting is complete, and you're satisfied that everything fits well, then the parts should be disassembled and prepared for soldering.

### **Soldering the Fittings**

Making a good sweated joint with copper tubing and fittings is the only real skill that is needed to build either of these stills. It is an easy skill to acquire, but it does take a little practice to get it right if you've never done it before.

To do it right, the parts to be joined must be scrupulously clean. The clean up can be done with any appropriate tool such as sandpaper, wire brushing, or polishing with steel wool.

When it's ready for soldering the joints should have a bright, almost golden color. The joint should then be fluxed. When you buy the lead free solder for this project, make sure you get the proper fluxing compound to match. Spread the flux evenly over both joint surfaces with a small fluxing brush or similar applicator, and assemble the joint.



The secret to sweat soldering is to make sure the entire fitting is evenly heated to the point where it will melt the solder when you apply the solder to the joint. Sometimes this can be difficult with large diameter tubing (2-3") because the tubing draws a lot of heat away from the joint. Make sure your torch has enough capacity.



Turbo flame propane torch heads are the minimum you should consider for this purpose. They are available at most hardware stores. An old style blowtorch also works well when working with the 2" and 3" fittings.

Once the joint is hot enough, the solder will run freely around the joint and will be sucked into the joint by capillary action. While keeping the heat at the bottom of the fitting (not on the joint) feed the solder wire around the joint until a small bead at the top of the joint appears. Then, with a shop rag (or leather gloved hand), wipe this bead of solder from the joint and remove the heat. This will provide an even tin finish to the joint.



With a little practice, you will soon find you can even make the solder run uphill towards the heat source, and that you can solder the joint without repositioning the assembly.

Whenever possible during the soldering of the assembly, clean out the inside of the joint after soldering with a brush and solvent to remove any flux or oxidation debris before going on to the next joint. It will make your first batches taste a lot better.

### ***Silver Soldering***

There are really two kinds of soldering. The first, discussed above, is done at relatively low temperatures (below 800° F. and usually about 450° F.) and is widely used in the plumbing and electrical trades. The solder commonly used was a 50/50 mixture of lead and tin.

The second type, long referred to as silver soldering, or silver brazing is done with a silver alloy that melts in the 1100° to 1600° F. range, depending on the amount of silver in the alloy. This commonly varies between 45% and 70%.

Unfortunately, the advent of lead free soldering requirements for the low temperature applications, has resulted in some solder being marketed as "Silver Bearing" or "Silver Solder". These lead free solders contain only a fraction of a percent of silver and they melt at temperatures in the 430° F. range. They should not be confused with the solder used in the silver soldering or silver brazing process.

This distinction is made at this point because, with one exception, all the fittings in the stills presented in this guide are all soldered with a low temperature lead free solder.

## BUILDING A HOME DISTILLATION APPARATUS



The one exception is the joint at the reflux column flange adapter where a copper coupling is joined to the steel exhaust flange with a 45% silver alloy that melts at about 1370° F.

This temperature is below the melting point of either the copper coupling or the mild steel flange, and the parts can be attached with a propane/Mapp® gas hand torch.

Now that we've got all the generalities out of the way, it's now time to begin the actual construction of your still.



## Internal Reflux Condenser

### Condenser Construction

In the context of a still, the condenser is a device that cools down whatever hot vapors that flow through it to the point where the vapors condense into a liquid. The condenser in this model is the most important part of the assembly because it controls the internal re-distillation process as well as separating out the final output.

Depending on the still design, the condenser may be located at different positions to provide different functionality in the still operations. The traditional reflux still design, shown on the left, includes a condenser and holding drum mounted at the top of the column. The holding drum is fitted with valves that allow the distillate to be routed back into the column, or directed out to a collection vessel.

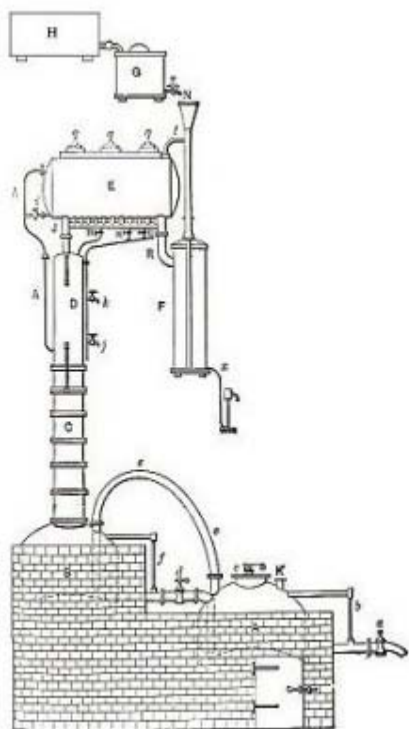

In the still we are building in this section, there is no condenser or reflux holding tank at the top. The reflux is produced inside the column by cooling tubes that pass through it.

Both the distillate output and the reflux flow are controlled by the amount of water that is circulated through the large, jacketed condenser shell of this type of still.



### Jacketed Condenser

Condensers can be designed in many ways, but for a lot of reasons, as you'll see in the next paragraphs, a jacketed core condenser is particularly well suited for this still. With jacketed condensers, a circulating and cooling water supply runs between the jacket and the core. This condenses the liquids contained in the hot vapors coming from the column and going through the core.

Here's a sketch of what the insides of the condenser look like:

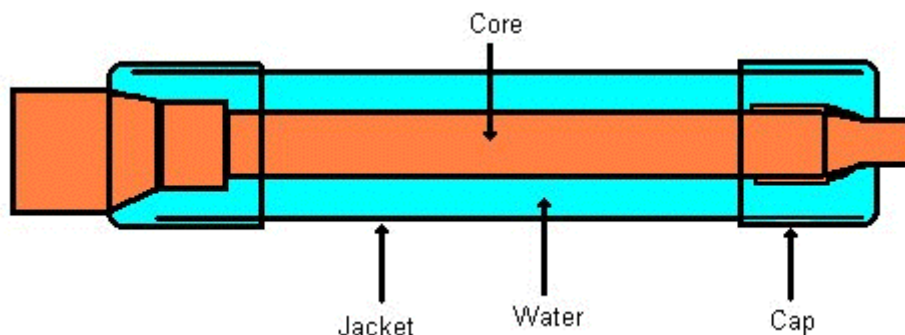

Simple as it might seem, there are a lot of considerations behind making a proper condenser for the kind of column we want to build.

Most low capacity distillation devices use a small capacity condenser. This is because they are designed for only one purpose: to drop the temperature of the distillation vapor to the point where the liquid separates out of the vapor.

That usually does not require a great deal of cooling. Pot stills sometimes just use a coil of tubing that cools the vapor by just exposing it to the surrounding air temperature.

But keep in mind we are building a reflux still. That is a more sophisticated design. In the course of its operation, the reflux still produces a much higher quality of distillate than the pot stills because it effectively re-distills the mixture many times before it is drawn off from the still.

So, to accommodate these needs, we've designed this still with a larger cooling capacity incorporated into the condenser. We've done that because we need not only the cooling required to condense the distillate vapors, but also to carefully regulate and control the temperatures inside the reflux tower.

To properly utilize the extra cooling capacity, we've made the water supply and drain lines from 1/2" copper pipe and run these cooling lines through the reflux column as part of the normal cooling circulation. The primary purpose of these lines is to control the amount of re-distillation (reflux) that occurs inside of the column.

### Condenser Cooling Flow

Since the cooling is so important to the operation of this still, it might be in order to touch on just how this is done.

In the sketch shown below you can see that the input cooling water is circulated first through the bottom of the column, then through the condenser, and finally back through the top of the column again.

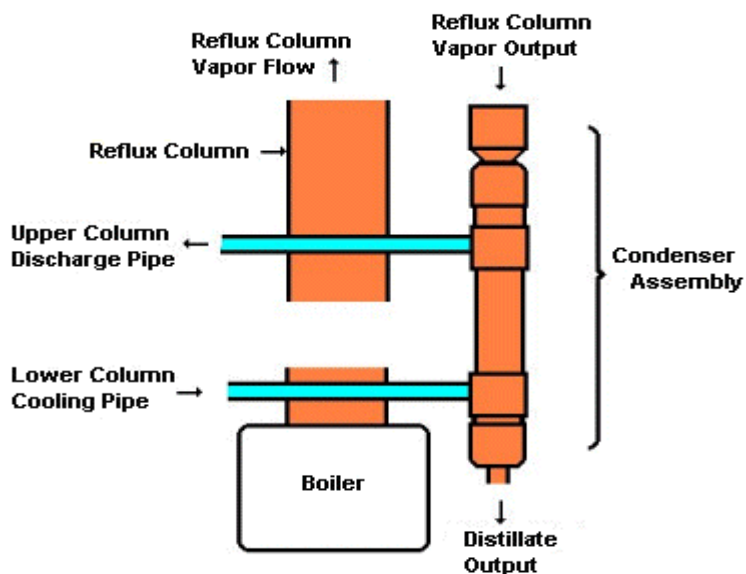

The rather large surface area of the copper jacket of this condenser acts as a radiator. It dissipates the heat conducted both by the lower input cooling pipe and the heat absorbed from the column vapors by the water as it passes through the column on its way to the condenser.

The jacked condenser is also easier to fabricate. So with these points in mind, it's time to start building the still.

The first step in building the still is to fabricate the condenser core assembly.

### Core Construction

The condenser core is the innermost tube that runs inside the water jacket of the condenser. It's made from a piece of 1" tubing and two copper fittings.

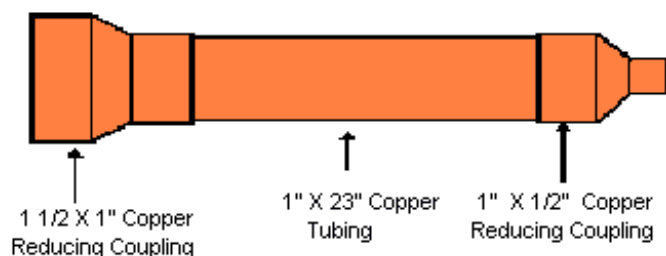

To make the core you begin by soldering together a 1 1/2" X 1" reducing coupling to a 23" length of 1" pipe. Be sure to clean the fittings and pipe with sandpaper or a stiff wire brush so it shines.

Then brush on some flux to both pieces before soldering, and use lead-free solder on all joints.

When you heat the joint enough with a torch, the solder will be sucked up into the joint. While the solder is still runny looking and shiny, wipe the joint with a clean rag. Makes a nice finish on the joint. Then solder a 1" X 1/2" reducing coupling on the other end in the same way. When you get done, it'll look like this:



This is a good time to run a brush or wet cloth through the core to clean up any flux that may have run into the tubing and fittings.

### Condenser Jacket Overview

The next step is to build a jacket that fits closely around the core. That will allow a thin, fast moving, layer of water with a lot of surface area to circulate around the core and quickly absorb the heat. In turn, it also allows the condensation rate (both internal and external) to react as quickly as possible to changes in the water flow.

Since the column output is made of 1 1/2" piping, we have to reduce this down to 1" piping for the core, and then make the jacket out of 1 1/2" pipe. That will leave a 1/4" space surrounding the core for the water to circulate.

## BUILDING A HOME DISTILLATION APPARATUS

To do this, we have to do some strange things to the end caps of the jacket so that it will match the underlying core plumbing. Here's what's involved:

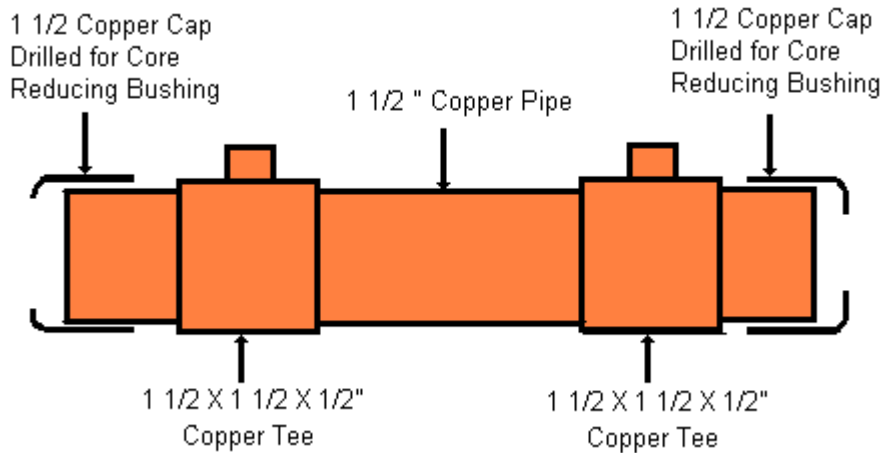

The hardest part is to cut the right size holes in the caps so they will fit nicely with the core. One cap has a  $1\frac{1}{8}$ " hole drilled in the end, and the other cap, a  $\frac{5}{8}$ " hole.

Cutting such large holes in the caps is difficult if you don't have bi-metal hole cutters of the right size. In that case you'll need to use a small drill bit to drill around a circle of the right size. The ragged edges can be smoothed with a rat-tail file or a die grinder tool.

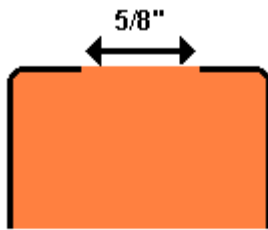

Bottom Cap

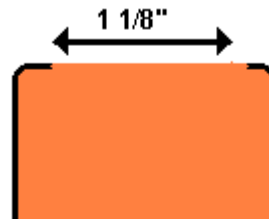

Top Cap

### Condenser Jacket

When the caps are done, you have to cut two nipples of 1 1/2" pipe each 2 1/2" long, and a piece 17 1/2" long for the main jacket.

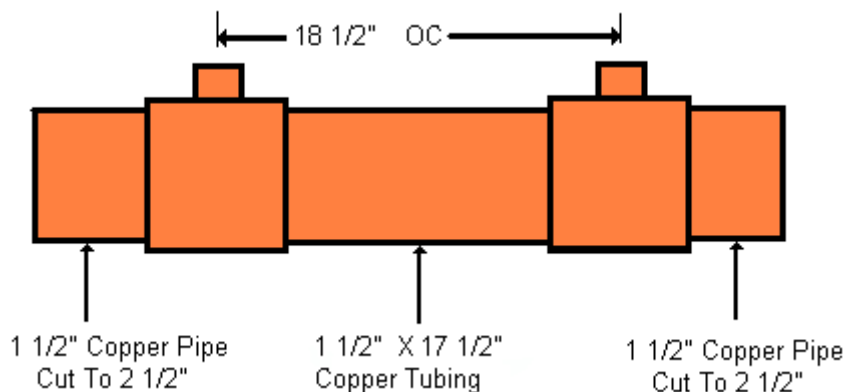

When you assemble the jacket, make sure the 1/2" reducing tee outlets are 18 1/2" on center. Later on you will see that it is important to insure that the cooling tube holes in the reflux column match this dimension.

The more important dimension is the overall jacket length. When the core is placed inside the assembly, it should fit snugly at both the top and bottom caps. You can adjust the length of either one of the cap fittings (before you solder them) to make any fine adjustments.

Now you can complete the assembly by putting the core assembly through the holes in the jacket end caps, making sure the Tee's are centered along the length, and soldering all the joints. The core and jacket should look like this just before putting them together.

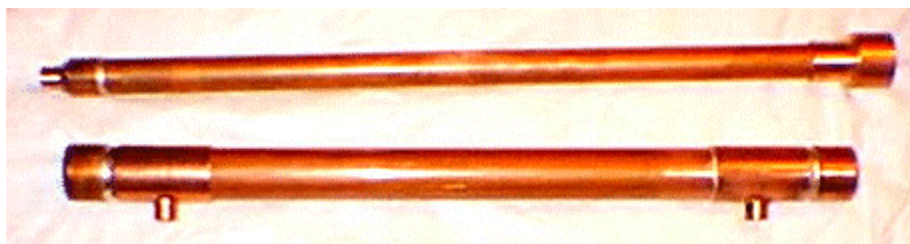

When you're satisfied that they fit snugly, solder the jacket tees and tubing together, making certain that the tee fittings are lined up in a straight line along the tubing center line.

Then put the end caps on, and install the core. You can adjust the end caps to fit snugly on the core. When everything fits right, solder it together. Then put it aside until we finish the reflux column assembly.

## Internal Reflux Top End

### Column Construction

The column for the Internal Reflux model is made from 2" copper tubing. It is three feet long, and has a thermometer mounted in the column cap. It is packed with Raschig rings (described later) to provide a large area condensation surface inside the column, and it has two cooling tubes that pass water through the vapors that rise through the column from the boiler. A Tee connector just under the cap provides a reduction to 1 1/2" tubing and an elbow connection to the condenser assembly.

The lower end of the column, internal to the boiler cap, is covered by a screen to retain the packing.

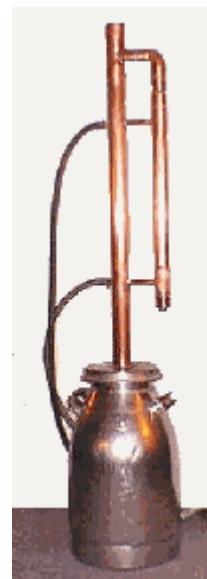

### The Column Head

The uppermost part of the column is called the column head. It consists of a cap, a thermometer, a 3" long nipple, and a 2 x 2 x 1 1/2" tee. It also includes a connection to the condenser assembly with two 1 1/2" x 2 1/2" nipples and a 1 1/2" x 1 1/2" elbow.

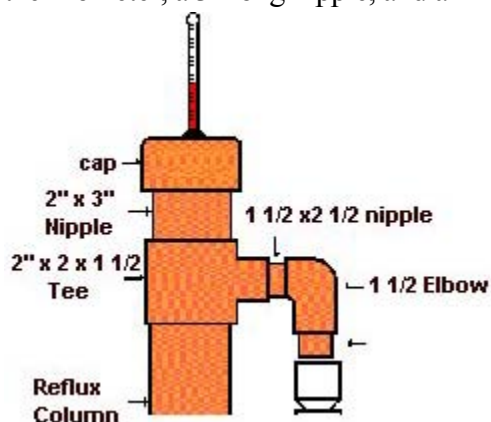

The cap is drilled in the center with a 3/8" hole to fit a rubber grommet and the thermometer stem. Not all stems have the same diameter, so you should make sure the hole fits your thermometer. The cap is *not* soldered to the column. This is to allow the column and packing to be back flushed and cleaned out by simply taking off the cap and hosing down the column packing.

### The Column Body

The column body is made of a 3 foot section of 2" copper pipe. It attaches to the 2 X 2 X 1 1/2" Column Head Tee on the top, and to the boiler (or flange) on the bottom end.

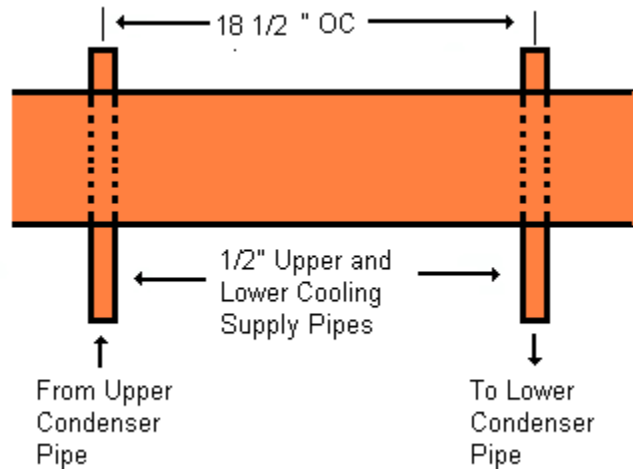

Two 5/8" holes are drilled on the center line of the column pipe, through both sides of the tube. The two holes should be about 18 1/2" O.C., but more importantly, they should match the upper and lower cooling tubes attached to the condenser. You should use a drill guide (or drill press) to insure that the holes are squarely in the center of the tube, and on the same line along its length.

When the holes have been drilled, clean up the top end and solder the Tee fitting, nipple, and the middle section together. Then install the 1 1/2" nipples and elbow to the tee connection. Do not solder these yet. They must be loose to allow final fitting to the column.

### Final Top End Assembly

Line up the two 1 1/2 X 1 1/2 X 1/2" tees on the condenser with the cooling tube holes in the column body, and install two 7" lengths of 1/2" tubing through the column and into the condenser tees. You should have a tower assembly now that looks like this.





## BUILDING A HOME DISTILLATION APPARATUS

Make sure everything fits OK and aligns well. When you're satisfied, remove the cooling tubes and condenser. Clean up and solder the 1 ½" elbow and nipples to the column tee. Finally, re-install the cooling pipes to the condenser to assure its alignment, and solder the remaining joints.



Since the cooling tubes will be clamp attached to a section of garden hose, you may want to relieve the strain imposed by the right angle direction change on the hose by soldering an elbow and short nipple to the end of each cooling tube, or by bending the tubing as shown in the picture at the left. This will allow the hose to feed into the still in a more vertical direction and thereby reduce the strain on the connection.

**Chapter**  
**11**

## Valved Reflux Still Head

### Valved Reflux Overview

This section of the manual deals with the construction of the Valved Reflux still. This model does not depend on an internal reflux and cooling flow for its operation as the still described in the previous sections did. Instead, this model is more traditional in that it has a condenser and a reflux holding container mounted in the still head. The bottom of the reflux holding container is equipped with two needle valves that allow regulation of both the reflux flow back into the column, and the flow to the output collection vessel.



### Still head Condenser

#### Valved Condenser Assembly

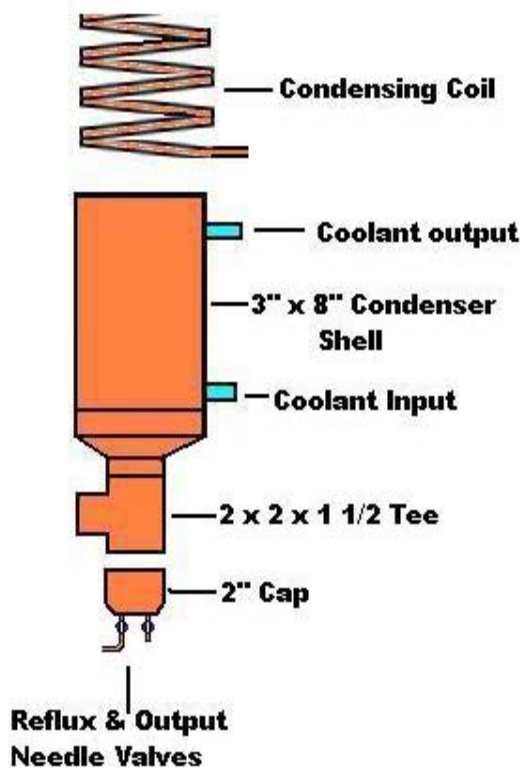

The condenser for this model still is contained in the still head assembly which is mounted on a connecting outlet to the reflux column.

Vapors from the column are directed through connecting Tee fittings from the column into the still head. The hot vapors then rise through a condensing coil mounted inside a 3" tubing shell where they are condensed.

The condensate then runs down inside the still head shell, and is enriched as it passes through the rising vapors. It then collects in the valved cap at the bottom of the Still head.

Two needle valves mounted on the bottom cap control both the reflux and output flows.

### Condenser Coil

The condenser in this still is much simpler to construct than the jacketed flow condenser used in the Internal Reflux still. The entire assembly only requires three soldered fittings.

The condenser core is made from a small coil (about 10 loops) of 1/4" soft copper tubing. The core is then mounted inside a 6" section of 3" copper tubing

The tubing can easily be formed around a section of 2" tubing or other pipe. Kinks can be avoided in the process if a flexible wire tubing bender sleeve is used as shown in the picture at the right.

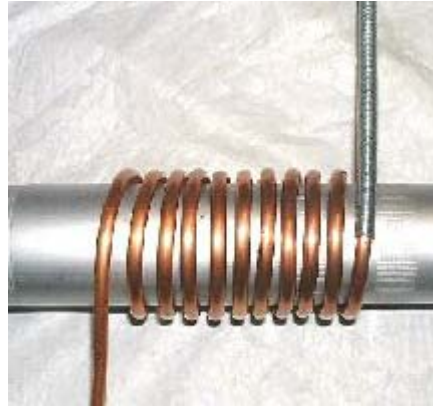

### Installing the Coil

Mounting the finished coil in to the casing has one area of difficulty. That is because the ends of the coil run parallel with the inside of the casing wall and

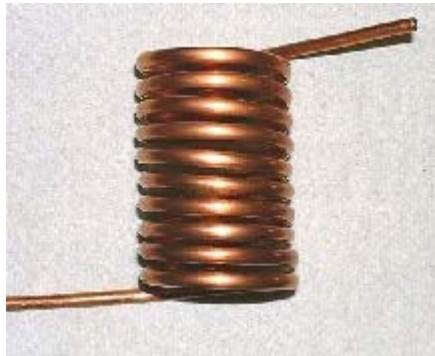

will not readily pass through a hole drilled on center through the casing.

To avoid this problem it is recommended that you terminate the coil on its last loop with a 90° compression fitting elbow.

This will allow a short piece of straight tubing to be run from the outside of the shell into the compression elbow inside the casing. The outside connection can then be completed with another 90° compression elbow, as shown on the right, to fit the water inlet and outlet tubing.



*Needle Valves*

The lower end of the still head is terminated with a 2" cap fitted with two needle valve controls.

When operating the still, the condensate from the overhead condenser will collect within this cap and its connecting nipple. The needle valves can then regulate what portion of the distillate will be distributed back to the reflux column and output distillate streams.



Chapter  
**12**

## Valved Reflux Column

### Column Overview

The column for the Valved Reflux still consists of a 28" length of copper tubing attached to a 2 x 2 x 1-1/2" reducing tee, and topped by a short nipple and cap.

The cap is drilled and grommeted to allow a thermometer to be mounted. Since the cap is not soldered, the entire column assembly consists of only three solder joints.

Before operation, the column is packed with Raschig rings (described later) to provide a large area condensation and reflux surface inside the column.

### The Column Head

The uppermost part of the column assembly consists of a cap, a thermometer, a 3" long nipple, and a 2 x 2 x 1 1/2" Still Head tee.

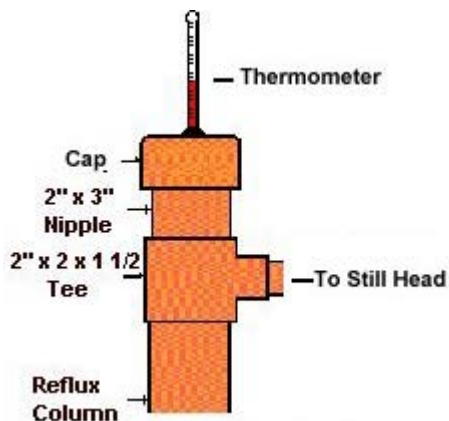

The cap is drilled in the center with a 3/8" hole to fit a rubber grommet and the thermometer stem. Not all stems have the same diameter, so you should make sure the hole fits your thermometer. The cap is *not* soldered to the column. This is to allow the column and packing to be back flushed and cleaned out by simply taking off the cap and hosing down the column.

The reflux column is made of a 28" section of 2" copper tubing. It attaches to the 2 x 2 x 1-1/2" Still Head Tee on the top, and to the boiler cap on the bottom end.

## BUILDING A HOME DISTILLATION APPARATUS

### Column and Head Assembly

The valved reflux still is quite easy to build and assemble as can be seen from the sketch on the right.

The major work to be done at this point is to fit the Still Head assembly to a short 1-1/2" connecting nipple and attach the other end to the column tee.

A similar nipple will be needed to fit the cap to the column.

At that point, all the joints should be cleaned, fluxed and soldered.

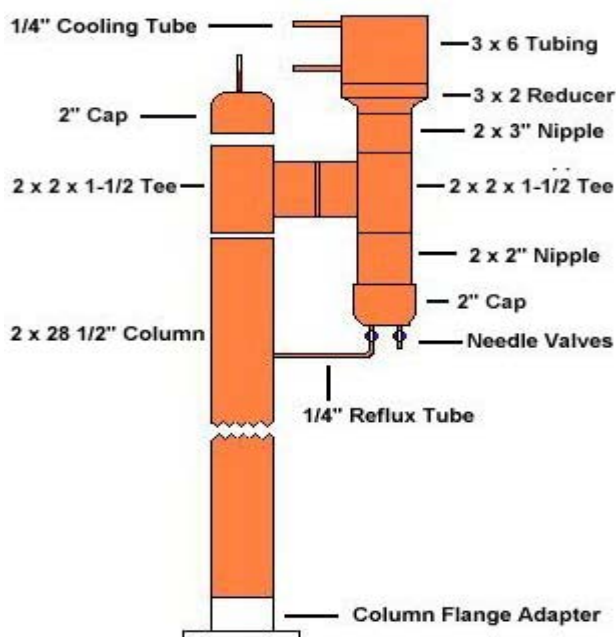

### Cooling Supply

The next step in constructing the valved still is to fabricate and attach the cooling lines to the overhead condenser.



These lines are made from 1/4" soft copper tubing and bent to shape so that they run up the column sides and fit the compression fitting elbows at the condenser coil.

The lines then run to the bottom of the column where they are connected to the water line hose with 1/2" tubing and elbows.

It is difficult to get 1/2 to 1/4" reducing fittings, so both upright nipples were fitted with drilled caps. The cooling tubes were then fitted and soldered to the caps.

Both hose fittings should then be soldered to the column adapter with standard pipe hold-down "U" clips for stability.



### Final Column Assembly

The last step in the construction of the valved still is to fit a short length of 1/4" tubing running from the center of the reflux column to a needle valve on the bottom of the still head.

It's best if this reflux line is tapered and curved like in the picture below.



Make the length sufficient so that the tapered drip end is centered in the column over the top of the column packing, and there is a slight downward slope from the needle valve fitting to the wall of the column.

When you've got the length and shape right, drill a hole in the column to run the reflux tube through, and install the other end in the compression fitting on the needle valve.

Last, solder the joint between the tube and the column.



## Attaching the Column to the Boiler

### Stainless Steel Milk Cans

Adapting the stainless steel milk can for use as a still boiler is quite easy because the modifications are all made on the removable flat topped cap.

The modifications involve cutting a 2 1/8" hole in the cap and then either TIG welding the column



directly to the cover, or building a small flanged adapter that will allow the column to be bolted to the cover.



The column should extend about an inch or two below the boiler cover so that brass screening can be used to cover the end. The screen keeps the tower packing (Raschig Rings) from falling into the boiler. A stainless steel hose clamp secures the screen to the bottom of the column.



If you would prefer to build the still without employing TIG welding, then you might consider using, a 2" copper adapter.



### Flange Adapter

A simple column adapter can be easily made from a standard 2" tubing coupling and a 2" automotive exhaust flange. A sketch is shown below.

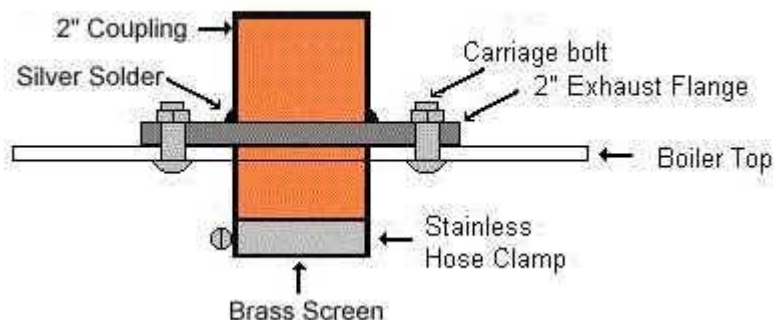

Building this adapter is quite straightforward except that the outside diameter of the copper coupling is 2 1/4". Unfortunately, in the U.S. the exhaust flanges are not made that size. And boring out a 2" flange is a very difficult job.

However, the problem can be avoided by first silver soldering a standard 2" coupling on top of the flange, and then making a collar that will pass up through the 2" hole and seat in the bottom of the coupling. Details of making this collar and pictures of the adapter are described in the [Building the Column Adapter](#) section below.

A cork flange gasket is also needed to fit the flange to the top of the boiler cap. Details of how it is made are described in the [Making the Gaskets](#) section below.

### Adapting A Stainless Keg

As it stands, the biggest problem with the stainless half keg is that it doesn't have a good fitting to attach the reflux column to, and it is very difficult to clean and fill it without brewery filling and steam cleaning equipment.

At the very least, the ball valve assembly must be removed before the 2" reflux column can be attached. But even if this is done, it is difficult to attach the column with a flange fitting because of the curved top of the barrel. Furthermore, simply having a 2" opening at the top when the flange is removed will not be enough to allow the boiler to be cleaned well.



The best way to overcome these limitations is to start out by cutting out a large circle in the top of the keg so that a separate cover can be attached. An 8" stainless steel mixing bowl with a 1/4" rimmed flange is widely available and makes a good cover.

### Cutting the Keg

To prepare for the cut you might find it easier to make a paper template by tracing and cutting out a circle inscribed around the rim of the mixing bowl as it is inverted over the paper.



The template center can then be found by using an ordinary compass. After the center is marked, draw another concentric inner circle  $\frac{1}{2}$ " inside the first. Then cut the template around the inner circle line. The template will now be the correct size for cutting the hole.

To center the template on the top of the keg, you might find it easier to cut an X with about 3" legs through the center of the template. This will allow you to fit the paper over the ball valve on the top of the keg and then center the template on the keg top.

When the template is centered, scribe a mark around it with a felt tipped pen. This will mark the top of the keg with the cutting line.



The hole can be cut with an ordinary saber saw, but the cutting will go much faster if you have a larger reciprocating saw for this job. In either case, you will need to drill a pilot hole just inside the cutting line circle to start the cut.

When you've finished cutting the hole, use a round file or a die grinder to remove the burrs and smooth out the inside edges of the cut.

### Anchoring the Cover

The mixing bowl cover is anchored to the keg by four 1/4" bolts. Since the metal on the top of the still is too thin to hold a thread, four 3/8" holes were drilled around the outside rim of the bowl flange to allow the insertion of threaded fastener nuts.

Threaded fastener nuts were used simply because they were simple and convenient. A complete kit for this tool, including an assortment of threaded rivets is available at a cost of



about \$15.00 USD.

There are also a number of other ways that threaded studs can be attached to the keg to allow the column to be bolted on.



The bolts are inserted through 1 1/2" fender

washers that clamp down on the outside rim of the mixing bowl cover. Because the top of the keg is domed, the washers were bent almost in half to compensate for the drop in elevation on each side of the bolt.



### Building the Column Adapter

To allow fitting the still column to the keg cover, an adapter is made from a 2" automobile exhaust flange and a 2" copper coupling and bolted to the bottom of the bowl. And while these dimensions sound correct, they are unfortunately *inside* dimensions. That means that neither the column tubing nor the coupling can pass through the 2" hole in the exhaust flange.



Worse, the flanges are not made with 2 1/4" holes. That would allow the coupling to seat into the flange, and allow a 2" nipple to seat into the coupling from

the underside of the flange.

To avoid the expense of boring out the flange, it was decided that the coupling would be placed on top of the flange, rather than passing through it, and then silver soldered in place.

The consequences of that decision meant that the column tube would fit up to the coupling restriction on the top, but a connection to that coupling from the underside of the keg cover would not be able to pass through the 2" flange opening.



### **Fitting The Adapter and Cover**

It's necessary to make the column and cover removable as a unit in order to keep the column packing in place when the column is removed from the boiler.



With that in mind, you need to make up a collar of the right diameter and length to pass through the keg cover, and then seat into the coupling and flange from the underside.

Cutting a 5" nipple from 2" stock, and then making a hacksaw cut along its length will allow you to overlap the cut joint and reduce the diameter of the nipple enough to pass through the cover, flange, and seat in the underside of the coupling. Notice how this appears in the photo at left.

### **Covering the Column End**

The bottom end of this collar should pass through the flange and cover for about 3 inches. This will allow a covering of brass screen to be attached to the bottom end with a stainless steel clamp and ensure that the column packing will remain intact when the keg, cover, and column are disconnected.





### Making the gaskets

Cork gaskets are used on both the top and bottom of the keg cover. This material is generally available at auto parts stores in 10" wide rolls of 1/8" sheet cork. Once the gasket outline has been drawn, the gaskets can be easily cut out with scissors or a sharp utility knife. The job of cutting out the small holes for the bolts is made much easier if a hollow punch set is available.



The rim of the keg cover is used to make the pattern for that gasket. Once the rim circle is traced on the cork sheet, draw a concentric inner circle so that a 1/2" wide circular gasket will be described. You may elect to use the pattern made for cutting the keg top for this.

The adapter flange (without the collar) should be used as a template to scribe the flange outline and bolt-hole locations on the bottom of the mixing bowl. The flange is also used to draw the outline pattern on the cork gasket material. Use the big circular piece left over from cutting the rim gasket for this.

A felt tip pen does a nice job on both these tasks.

### **Finishing the Keg Cover**

Cutting a 2" hole in the bottom of the bowl so that the collar can pass through it and seat in the bottom half of the flange coupling will complete the keg cover. It should fit quite tightly in the cover and flange holes and does not need to be soldered or pinned with a setscrew.



The job of cutting the hole for the collar is made much easier if a bi-metallic hole saw is available. When this is finished, drill the marked flange bolt holes.

When all the cover holes have been drilled, insert the split collar through the cover as shown, and slip the gasket in place. The flange assembly can then be installed. At this point the cover assembly can be bolted together and set aside until it's time to attach the column assembly.



Ceramic Tower Packing From 5 Continents USA

## Column Packing

### Packing Materials

To wrap the construction phase up, the column has to be packed with something with a lot of surface area for the vapors to condense on as they pass up the tower from the boiler. There are a lot of things you can use to pack the tower. Recommendations range from marbles, glass beads, copper or stainless scrubbing pads, to broken automotive safety glass and others.

Packing is a poor word to use for this material. It implies something dense and difficult to pass through. What we really want inside the column is something that won't pack, burn, melt, dissolve, or release impurities or poisons into the vapor in the column.

We also want that material to have as large a surface area as possible, and at the same time offer as little resistance to the gas flow as possible. It should be easy to clean, and above all, it should not settle or pack down in the column.

And while that is a pretty tall order, there is a product that satisfies all these requirements. The product is called Raschig Rings. They are hollow cylinders made of unglazed ceramic material. They are made in many sizes but the 1/4" diameter is perfect for this kind of column. They look like this:



Courtesy Gert Strand <http://partyman.se>

Finding a good source Raschig ring sources are sometimes hard to find. A search of the Thomas Register of American Business turns up about 19 suppliers. But for the most part these suppliers are large companies, many of whom specialize in doing business with the big refineries and oil companies. As such, they really do not want to deal with a small laboratory or an individual distiller.

Some of the prices for 6mm Raschig rings can be shocking: one company wants \$80.40 USD for a liter quantity (you'll need two liters), and requires a \$300.00 minimum order.

Another wants \$24.90 for a box of 300 rings (there are 85,611 6mm rings in a cubic foot).

Under the circumstances, if you've decided to use this packing you should check out Gert Strand's Partyman website at <http://www.partyman.se>. The prices there are a fraction of the larger companies on the Thomas Register.

If you are located in the US, you can save some postage charges by contacting the Brew Haus at <http://brewhaus.com/Store-USA/Web/>. They currently are selling a liter of 6mm Raschig Rings for \$15.95.

As a last resort, you might take the time to cut up a few thousand 1/4" slices from some 1/4" copper or stainless tubing if you have the scrap laying around and a lot of time. But if you have to buy it new, even copper tubing costs about \$0.40/ft USD, and it's definitely not worth the time to cut it up.

Probably the best alternative to Raschig Ring packing is stainless steel or copper pot scrubbers. You can get them at most local grocery stores. They come highly recommended from several sources, and while you may not get 95% purity, remember that you'll need to dilute the distillate anyway if you intend to drink it. Just be sure you clean them up by boiling them in water before you use them, and don't pack them too tightly in the column.

## **BUILDING A HOME DISTILLATION APPARATUS**

No matter what packing you choose, fill up the tower to just above the top cooling tube if you've built the Internal Reflux still. Otherwise fill it up to a point just under the reflux return tube on the Valved Reflux column. Put the cover cap on, and attach the cooling hose couplings with stainless hose clamps. You're almost ready to go!





Electric Hot Water Boiler From Bradlee Boilers Ltd.

## Heating the Boiler

Now that you've got a real still, better give some consideration as to how the boiler will be heated. The two most common choices are electric or gas. Like most things in life, each selection has its' own merits and demerits.

### Electric Heating

Electric immersion heaters are readily available for hot water heaters in the U.S. in either 1500 or 3000 watt sizes. But if you want a precise regulating of the heat ( and that degree of control may not be needed) then these heaters will require an additional, and very expensive voltage controller.

The U.S. immersion heaters also require a separate 120/240 volt AC source to operate, and they respond very slowly to controls that would regulate the boiler temperatures. They have to be mounted inside the boiler (a messy thing to clean) and the wires run to the outside (a hard thing to seal from leaks). The wiring connections must be enclosed in approved electrical boxes and, to be safe, the work must meet a lot of electrical code specifications.

External electric hot plates avoid the internal mounting and wiring problems, but they are very inefficient. They are generally limited in the U.S. to about 1600 watts on a 110 volt alternating current house circuit. That amount of energy may work, given enough time, for small boilers but many find the boil up time excessive for boiler sizes over 5 gallons.

On the plus side, electric heating is much better suited for indoor use. It is cleaner, safer (if wired properly), needs no venting, and provides much less risk of alcohol fires or explosions.

### **Heating with Gas**

On the other hand, using natural or bottled LP gas to heat the boiler will avoid many of the boiler fabrication, electrical wiring and cleaning problems associated with electric heat.

Adjusting the heat level with Gas controls is very flexible. The heat can easily be adjusted to any setting from off to maximum, unlike the typical Low, Medium, High settings on electrical switches.

That is not to say that electrical Potentiometers cannot refine this control, but they cost more than the still, and they consume more energy in the process.

A gas heat source will also react much more quickly to control changes than electric. It's also capable of producing far more heat than electrical household circuits can supply.

Gas makes the entire apparatus much more portable. That portability gives you the freedom to move the whole setup out to the garage, barn, utility shed, deck, backyard, or even the deep woods.

A small 15,000 BTU cast iron outdoors cooking burner can be bought for under \$10.00 in the U.S. (including shipping) that does an excellent job. It will bring 7 ½ gallons of cold (4° C.) water to boil in less than an hour. The burners also come in higher BTU ratings if you are impatient with bringing the batch to boil.



The downside is that gas heat, in a confined space and without proper ventilation, will deplete the oxygen in the air. It can also produce dangerous carbon monoxide if the burner is not adjusted properly. It is best used outdoors.

Lastly, and perhaps most importantly, the open flames of gas heat are much more likely to start alcohol and combustible fires if great care is not taken.



Zambia Cooling Towers  
Industrial Water Cooling Ltd

## Cooling the Still

### Overview

Next to heating, cooling the still is the most important operation. Both stills in this guide are cooled with a supply of running water. But because of their different approaches to controlling the reflux in each, they have different cooling requirements, consume different amounts of water, and require somewhat different operating procedures.

### Internal Reflux Still

The condenser in this still is capable of circulating up to 400 gallons of water per hour. And while you do not need anywhere near that amount of circulation for normal



distillations, a typical batch will require about 6 hours of cooling circulation. Obviously, at full rate, the 2,400 gallons of water used might overtax the well supply or fill the septic tanks of those folks that do not have access to city water and sewage facilities.

### Cooling Recirculation

If you are concerned with water conservation for any reason then you may want to consider using a recirculation tank and a submersible pump to provide the cooling and drainage for the apparatus. This setup will allow you to complete a 6 hour distillation run using about 50 gallons of cooling water.

The major disadvantage of this approach is that the temperature of the cooling water in the tank gradually rises as heat is exchanged in the condenser. As it rises, you will need to

either increase the circulation, or replace some of the heated water to keep the temperature and distillation rate a constant.

A “Y” valve on the pump outlet makes it easy to either circulate the water into the still or to empty the holding tank to a drain. A separate supply hose should then be used to refill the tank.

### **Recirculation Tanks**

A suitable recirculation tank can be found from a number of sources. Most department and hardware stores have inexpensive (under \$10.00 USD) plastic storage bins that make adequate holding tanks. They hold between 14 to 28 gallons of water. Clean garbage cans and metal drums will work even better, and are best for longer distillation runs or where sufficient coolant buffering is needed. Also, you always have the option of cascading multiple tanks.

### **Submersible Pumps**

There are a number of sources that you might consider when selecting a re-circulating pump for your tank.

If portability is important, a marine bilge pump powered by a 12vdc source is a good solution. It pumps about 300 gal/hour, and costs about \$30.00. RV water pumps are also a good consideration. They pump about 100 gal/hour and cost about \$15.00. They draw only an amp or two of current, and can run for over several days on a fully charged storage battery.



I use a small submersible utility pump to drive the re-circulation of water from the tank to the condenser. It cost about \$60.00, and is refuted to pump up to 2000 gallons per hour. However, when I drained the re-circulating tank through 5/8” garden hose, it only delivered about 360 gallons per hour.

Normally, I wouldn’t consider buying a pump like this for a still that costs less than \$100. In fact, the only reason I use it is because it was hanging around waiting for a flood (something like my generator waiting for a power failure).

It does, however, provide excellent control, and since it is a centrifugal type of pump, the water flow can be regulated (even shut off) with a simple ball valve on the condenser input line without damaging the pump.

### Valved Reflux Still

The Valved Reflux still has a much smaller cooling capacity than the Internal Reflux model. As a consequence, it requires much less water consumption and drainage.



The reason for this is that there is no need to supply cooling to the column itself in order to provide the necessary reflux circulation. All of the condensation is done by a small diameter coil located at the top of the still head, located outside the column itself.

For that reason, a recirculation tank and pump may not be as practical, or useful, when used with this design.

On the other hand, control of the cooling with this still is much simpler than with the Internal Reflux still. This is because the cooling flow does not affect the reflux flow in the still.

Consequently, the only adjustment to the cooling flow that needs to be made is to insure that there is enough circulation to completely condense the vapors surrounding the coil, and the heat is low enough not to drive the vapors past the coil and out into the atmosphere



Fossil Fueled Power Plant Control Room  
STN ATLAS Elektronik GmbH

## Still Operation

### Safety

Using this still involves working with heat, steam, electricity, gas, and possibly explosive vapors. You must take extreme care to prevent injury, fire, or explosion if you ever decide to use the device.

Some view using a still to distill alcohol as being akin to boiling gasoline on your home gas or electric stove. Over time more than one person has been maimed or killed in the explosions and fires resulting from these activities. You must be careful at every step in these procedures.

### Initial Checkout

Before you use the still for any purpose, you should test the apparatus by distilling a gallon or two of water. This preliminary test will verify that the joints don't leak, that there is sufficient heat input to do the job, and that there is enough cooling to control the distillation. It will also help clean up any remaining flux from the joints soldered during construction.

### The Internal Reflux Still

To start the run, mount the boiler on top of the heat source, fill it with a gallon or two of tap water and attach the column to the boiler. Then connect the cooling hoses on the column to the water supply and drain.

Do not allow the cooling water to circulate through the apparatus at this time.

## BUILDING A HOME DISTILLATION APPARATUS

Then turn on the heat to its highest setting and insert the thermometer in the top of the column. The bulb should be seated to the level of the upper column tee connection (where the vapors flow to the condenser).

In a short time (about 10 or 15 minutes) the water should be boiling to the point where vapor and liquid can be seen exiting the condenser. The thermometer should indicate that the boiling point temperature (100° C.) has been reached in the column.

The next step should be to determine the maximum distillation rate of the still. To do this you will need to open the cooling flow to the maximum and increase the boiling rate to the point where the condenser can no longer condense all the vapor.

It's easy to recognize this point because you'll be able to see a lot of steam mixed in with the distillate running from the still.

When you've reached that point slowly back down the heat to the point where the vapors no longer exit the condenser. In doing this, be careful not to reduce the heat to the point that the thermometer drops below the boiling point (100° C.). You should now be at the maximum distillation rate settings for this still.

When you have reached that point, measure the time needed to collect exactly 250 ml of distillate.

Knowing the maximum distillation rate is important because it forms the basis for estimating the reflux flow. Recognize though, that in this exercise we are working with water. Different mixtures in the pot will have different distillation temperatures and different rates of distillate flow. You will need to redo this exercise to get the right basis figures for the distillation at hand.

Before finishing up the initial run you might find it worthwhile to time and measure a few distillate volume readings at different cooling settings to get a feel for the control sensitivity and distillation rates. Finally distill about a gallon of water to finish cleaning out the still.

### **Shutdown**

When it's time to shut the system down you should always follow a set sequence of actions in order to avoid problems. The shutdown sequence is:

1. First remove the thermometer cap from the top of the column.  
Use gloves, it may be hot.
2. Next turn off the heat.
3. Finally shut off the cooling water circulation.

This is important, because if you are using plastic tubing to collect the distillate from the condenser, it could get kinked or obstructed in some way. That would seal off the apparatus from the air. If this happened while it was cooling down, a vacuum would be formed within the still as the vapors inside condense, and the air pressure outside could crush the unit.

When the unit has reached room temperature, disconnect the cooling hoses, and back-flush the column with water. Then remove the cover and clean and flush the boiler.



### Valved Reflux Still

Operating the valved reflux still is much easier than running the Internal Reflux still because the valves on the still head provide direct control of the distillation and reflux rate.

### Initial Startup

As with the Internal Reflux checkout run, you should begin the checkout run by filling the boiler with a gallon or two of water.

Next install and bolt down the top end with the keg clamp screws, close both needle valves on the still head, and connect up the cooling hoses. Then install the thermometer in the column cap.

At this point you should turn on the heat at high setting to bring the water to boil, and also turn on the water circulation,

The temperature will rise to 100° C. when the boiling starts, and steam will begin to appear at the top of the still head. When this happens, turn down the heat just enough to stop the vapors from escaping but without changing the temperature as measured by the thermometer.

When you have reached this state, the water will still be boiling, but all the vapors are being condensed at the coil in the still head. The condensed distillate will then run down the still head and collect in the valved cap and nipple at the bottom of the assembly.

Opening the collection valve at this time will allow you to measure the distillation rate without any reflux (max distillation rate). As with the Internal Reflux instructions above, measure how long it takes to collect 250 ml of distillate.

Once the max rate has been determined, you can then close the output valve and open the reflux valve. The system will then be operating in total reflux (all distillate is returned to the column).



Finally, after running under total reflux for a few minutes, adjust the output valve to allow a collection rate of about 1/3 of the maximum rate. That will mean that about 2/3 of the distillate will be flowing back into the column for re-distillation, and the other 1/3 will be collected as output.

At this time you might also experiment with adjusting the reflux valve at this point to increase or decrease the amount of distillate returned to the column or retained in the holding cap,

After you've become comfortable with the operating controls shut down and clean up the system.

### **Shutdown Procedures**

The valved reflux still water and heat connections can be shut down in any order without any danger of implosion because the column is always vented to the air at the top of the still head.

Nevertheless, it is good practice to first remove the column cap and thermometer (use gloves). This will help to protect accidentally breaking the thermometer when removing the column from the boiler.

Also, please be careful in dealing with the near boiling water remaining in the boiler, and with disconnecting the heating supply (both electric and gas).

After disconnecting the water hoses you can then remove the top end from the boiler for cleanup.

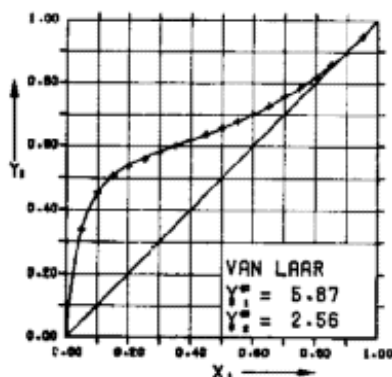

Ethanol Water Equilibrium Graph  
Used in Distillation Column  
Optimization.

## Optimizing Still Operations

### Temperature Considerations

Most folks don't pay much attention to such trivial things as boiling a pot of water. But since you're on the road to some serious distillation, it always helps to know what's really going on when you do that. In fact, the subject of boiling water is serious enough to some people that they have devoted web pages to the subject just to help others understand the process.

Wayne Pafko covers this well in his "History of Chemical Engineering" site at <http://www.pafko.com/history/index.html>. To save you the inconvenience of having to interrupt this section he has courteously provided the following two graphs from his site.

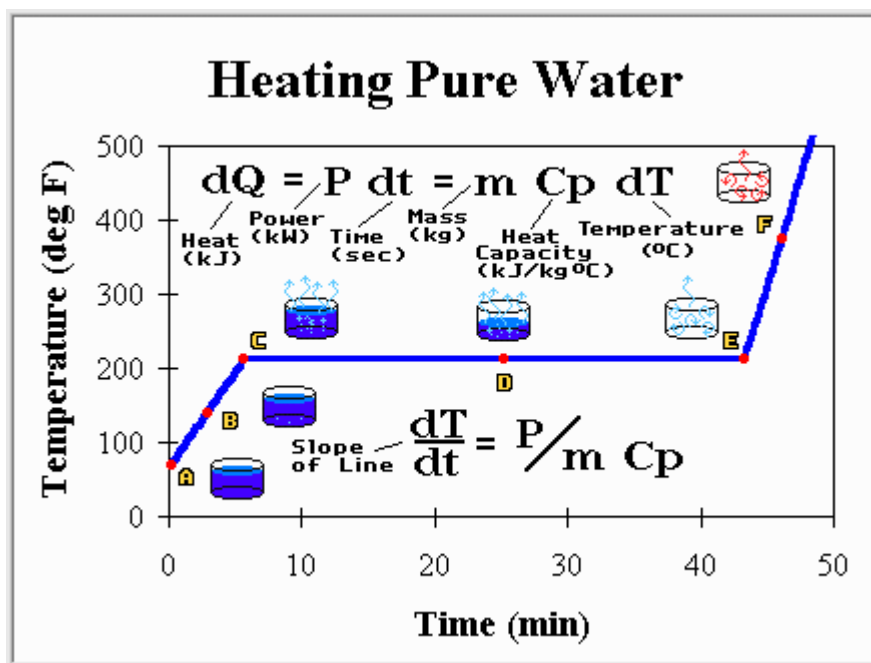

Wayne Pafko - History of Chemical Engineering

This is a graph of how the temperature varied when you ran the initial still shakedown. The tap water started out near room temperature at point "A" in the boiler, and as heat was applied the water temperature rose at a constant rate until it reached the boiling point at "C" about 8 minutes later.

If you got to the point of doing the initial test run you probably noticed that the column thermometer on the still was not of much use during this run. It missed the warm up, and sat at room temperature until the steam moved up the column and reached it. Only then did it begin to show the vapor temperature. Then, somewhat strangely, the temperature didn't change throughout the whole distillation even though the heater was still pouring energy into the pot all during that time..

Makes you wonder why the still has a thermometer on it. Fact is, the only useful information we got from it during the initial run was an indication of when the water was boiling and what the temperature of the steam that was produced. Surely, we don't need an expensive thermometer for just that!

But there is a good reason to have it there. In the shakedown run we dealt with only one component in the still,. Things change when you deal with a mixture of things in the pot.

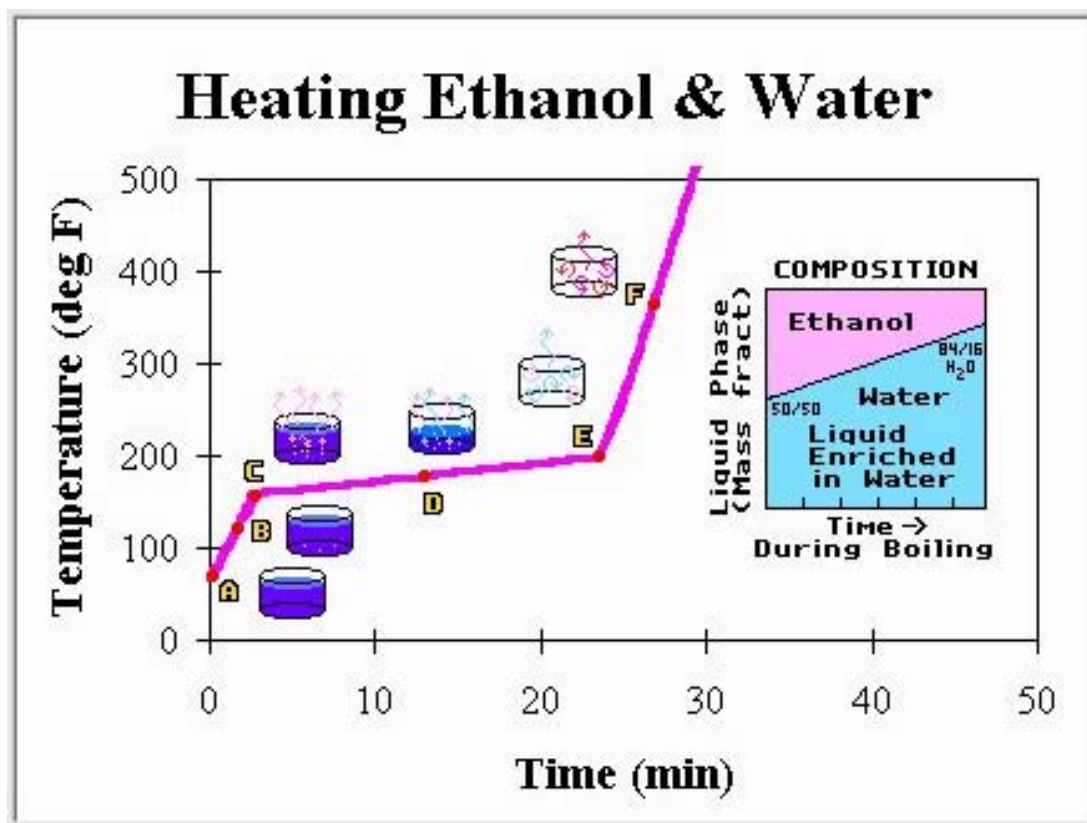

Wayne

Pafko - History of Chemical Engineering

When you blend two liquids of different boiling points together, the resulting mixture usually boils at a different temperature than either of the components. Also, depending on some of the other physical characteristics of the components in the mixture, you will notice a difference in how long it takes to heat the mixture to its boiling point. Finally, you'll find that once boiling, the temperature of the vapors that are boiled off gradually increase as you continue the boil.

All of these effects are shown in the graph above which shows how the temperature changes over time when an ethanol/water mixture is boiled. Notice that the mixture heats up to boiling in less than five minutes (it took the water about 8), but the boiling temperature is only about 170° F (the water boiled at 212° F). Notice also, that once boiling, the temperature rises gradually over the next 20 minutes until all the mixture is evaporated (point E).

You'll see this kind of temperature behavior if you ever decide to distill alcohol. It's best understood by looking at the little side graph above which shows how the concentrations of water and ethanol in the vapors vary during the distillation process. The mixture starts out with about 50% water and 50% ethanol, but the alcohol in the mixture boils at a lower temperature than the water, and evaporates more quickly. Consequently, as the boiling continues, the vapor contains less and less alcohol and more and more water. This

accounts for the gradual rise in the vapor temperature, because toward the end there is much more water than alcohol, and it takes a higher temperature to vaporize the water.

That's the primary reason for the still to have a thermometer mounted at the top of the column. It lets you monitor the vapor temperature as you distill. In turn, this lets you judge the purity of the distillate output without having to measure it with a hydrometer. In a batch distillation, the thermometer becomes a very useful tool to indicate when to begin collecting the distillate, and when to cut it off. This is your first step in optimizing your distillation.

***Purity Re-Visited***

If you are distilling alcohol you most likely will be working with a beer made by fermenting some sort of sugar based mash. If you intend to use the distillate as a beverage, then there are a couple of other considerations you'll need to deal with during the distillation.

Going back to an early chapter on distillate purity, you'll probably recall the results of a chemical analysis on the distillate recovered from a molasses based mash:

Organic acids	0.152 %
Esters	0.071
Aldehydes	0.015
Furfurol	0.00019
Higher Alcohols	0.412
Nitrogenous Substances	0.0006

Some of these compounds play a part in judging the quality of the spirits that goes far beyond the concentrations shown in the table. That's because the human senses of taste and smell are far more acute in many cases than the analytical techniques used to express their concentrations in the liquor.

### *Fusel Oils and Congeners*

One of the more widely known groups in the table is the higher alcohols, sometimes called fusel oils. In general, the compounds in this group are a mixture of volatile, oily liquids with a disagreeable odor and taste. Before industrial production of synthetic amyl alcohols began in the 1920s, fusel oil was the only commercial source of these compounds, which are major ingredients in the production of lacquer thinner.

Another, somewhat wider, grouping of the compounds listed are called congeners. Congeners include the aldehydes, esters, and primary alcohols such as methanol and isoamyl alcohol. Congener content is significant because they can act as CNS depressants, mucosal irritants, and produce nausea. Taken together, they appear to increase the duration of intoxication, the amount of hangover, and the toxicity of alcoholic beverages (Kissin 1974, Murphree 1971)

Not surprisingly, in the beverage industry, congeners and fusel oils are ordinarily allowed to remain in the finished distillation products. They are the major ingredients that differentiate brand name whiskeys by taste.

In many circles, the mark of a poorly distilled spirit is a colossal hangover. That malady can be avoided by producing a highly refined spirit, but usually at the sacrifice of some of the characteristic tastes associated with the drink. The choice of how you handle this issue is really up to you.

### *Heads and Tails*

Whenever you distill something, the most volatile products come out first. So when you distill a mash, the low boiling point compounds in it (in general the Nitrogenous Substances, Aldehydes, and Esters) will appear in the first distillate. This part of the distillation is commonly called the "Heads". You can prevent them from contaminating the product you are attempting to separate by watching the temperature and discarding (or saving for addition to the next batch) everything that boils off before you reach the boiling point of the target component.

But, depending on the nature of the wash, it's sometimes difficult to isolate the heads by simply monitoring the temperature. It's easy to miss the boiling points of those compounds that vaporize below 70° C when there is an excess of heat input, and the vapors rise up the column quickly to reach the thermometer bulb. Many experienced distillers carefully monitor the taste and smell of the first distillate from the still to insure that all the heads are boiled off before they begin the collection of the body of the spirits. Others simply discard a small (e.g. 150 ml) fixed amount, before beginning the collection of the ethanol.

A similar distillation cutoff point is also encountered as the ethanol nears depletion from the distillation. This phase is commonly referred to as the "Tails". The tails contain an increased amount of the higher boiling point compounds, such as the higher alcohols and

furfurol. These compounds can also spoil the taste of the spirits if the collection is carried on too long. A cutoff similar to that of the heads should be made.

Again, you can recognize this point by monitoring either the temperature or the taste and smell of the distillate. Many distillers simply limit the collection of the pure spirits to a narrow range of temperatures (e.g. 78.3 - 80 C), and then make the cut. Others sample the specific gravity of the distillate as it nears the end of the run. Still others use the smell and taste indicators.

In any event, there usually is considerable ethanol that can be recovered from that remaining after the tails have been cut. Commonly, the tail collection is saved for inclusion in the next batch.

### **Reflux Control**

As mentioned previously, the most important factor in achieving a high degree of purity in the distillation is the amount of reflux that is employed.

When you use this still, you should allow only a small part of the distillate output to be withdrawn in a unit of time, and let the rest be re-cycled back into the column. That's a rather simple way to control the amount of refluxing. The proportion of distillate returned to the column versus that which is withdrawn is called the Reflux Ratio.

In theory, the more reflux cycles that are allowed to take place the purer the output will be. In other words, high reflux ratios produce more refined products.

In practice though, you will find that as you increase the reflux ratio more and more, it produces less and less improvement in both the purity and the amount of the output. You soon reach the point where the whole operation becomes counter productive in terms of the time and heating costs needed to produce the distillate.

It's also important to recognize that no matter how many reflux cycles are applied to the process, you will never be able to get a completely pure distillate.

Under the circumstances then, a practical goal should be to produce a purer product than what you can buy commercially, and at the same time produce the product at the least cost.

All this then comes down to the big question:

**"What is the best reflux ratio to use in my still, and how do I regulate it ?"**

Like the question, there are at least two answers.

### **The Internal Reflux Still**

This type of still controls the reflux ratio by regulating the cooling flow through the tubes that pass through the inside the column. We estimate the reflux ratio by measuring the



maximum distillation rate at a given heat level with minimal cooling, and then regulate the cooling to provide an appropriate fraction of that rate.

Suppose, for instance, you can distill 1 liter/hour at a given heat setting with minimal cooling, and you want a reflux ratio of 3 to 1. Then you simply adjust the cooling flow (without changing the heat) to the point where only 250ml of output is distilled in one hour. That means for each 1000 ml of distillate passed in a unit of time, 250ml is withdrawn, and 750 ml is refluxed. That gives a reflux ratio of 3:1.

Coming back to the key question **"What's the best reflux ratio to use?"**

Unfortunately, that also depends on the column design, what's being distilled, an assessment of the output purity, and an evaluation of the costs involved in producing that purity.

It will take some experimentation on your part to get exactly what you want.

If you want to distill ethyl alcohol for instance, your best bet would be to start with a reflux ratio of about 3:1 with this still. Commercial operations, I've been told, use ratios ranging from 1.8:1 to 5:1 for distilling this product.

Under normal conditions then, and using this ratio, you should be able to produce about 5 liters of crystal clear, totally odorless, 190 proof spirit from a 20% beer in a about 6 hours of distillation.

The good part of tuning this still is that you have complete control over the refluxing. That also means you can make it behave exactly as you want.

### **The Valved Reflux Still**

It's a lot easier to control the reflux ratio with this type of still because it has separate valves to regulate how much distillate is returned to the column, and how much is withdrawn as a product output.

In turn, that allows you to set up and measure the maximum distillation rate by simply shutting off the reflux flow with a needle valve and then measuring how much output flows from the still in a unit of time.

Once you know the maximum output, it becomes an easy matter to throttle that back with the reflux valve fully open. The difference between the max output rate and the observed output rate will be the reflux rate.

And because of the dual valves, there is a great number of combination settings you may select once the max flow is known to either decrease or increase either of the flows without losing sight of a proper reflux ratio. But the bottom line is that, like the internal reflux still, you will have to experiment to get the best product.

## The Last Words

Well it's done. We've started from scratch, learned a little along the way, maybe got involved enough to actually build a still, and maybe even went further.

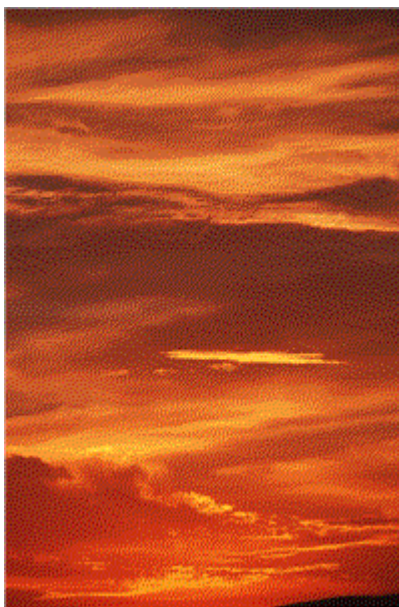

For me, it's been a lot of fun, a great experience, and a continuing adventure. For those of you who have traveled the entire course, I hope you are pleased with the results. More than that, I hope you get involved enough to improve on this basic apparatus and let others know about it so that they too, may profit from your experiences.

Who knows, with enough interest from those of you reading this, perhaps some of the more insensible laws of the land can be changed. And if they can be changed simply because you get involved, then you will have made a great contribution by giving everyone a bit more freedom to pursue those interests that do no harm to their neighbors.

In any case, with the apparatus you have just constructed, you will be able to isolate, and perhaps enjoy, many of the refined compounds derived from your distillation apparatus. That, for many, is reward enough.

## Appendix I – Cost Summary

### Materials and Cost

The materials used in the construction of both the Valved Reflux and the Internal Reflux stills are listed below along with their cost. Prices and availability can vary significantly depending on your location. These prices are representative of those found in the Northeastern area of the U.S. in 2001, and do not include the cost of the boiler vessel.

### Valved Reflux Still Top End Summary

<i>Component</i>	<i>Size</i>	<i>Qty.</i>	<i>Cost</i>
<b>Column Cap</b>	2"	1	3.00
<b>Cap Nipple</b>	2 x 3"	1	1.00
<b>Still Head Tee</b>	2 x 2 x 1½"	2	16.00
<b>Still Head Column Nipple</b>	1½" x 1¾"	1	.40
<b>Condenser Nipple</b>	2" x 3"	1	1.00
<b>Condenser Reducer</b>	3" x 2"	1	11.21
<b>Condenser Shell</b>	3" x 6"	1	2.22
<b>Cooling Coil</b>	¼" x 48"	1	1.60
<b>Coil Compression Elbows</b>	¼"	4	4.00
<b>Cooling Supply Tubes</b>	¼" x 48	2	3.20
<b>Cooling Inlet Caps</b>	½"	2	.60
<b>Cooling Supply Elbows</b>	½"	2	.80
<b>Cooling Supply Nipples</b>	½" x 3"	4	.50
<b>Reflux Cap</b>	2"	1	3.00
<b>Reflux Nipple</b>	2" x 3"	1	1.00

**BUILDING A HOME DISTILLATION APPARATUS**

<b>Needle Valves</b>	¼"	2	6.50
<b>Reflux Tube</b>	¼" x 4½"	1	.25
<b>Reflux Column</b>	2" x 28"	1	9.10
<b>Column Coupling</b>	2"	1	3.00
<b>Column Flange</b>	2"	1	1.75
<b>Tube Straps</b>	½"	2	.30
<b>Total</b>			<b>\$67.43</b>

**Internal Reflux Still Top End Summary**

<i>Component</i>	<i>Size</i>	<i>Qty.</i>	<i>Cost</i>
<b>Column Cap</b>	2"	1	3.00
<b>Cap Nipple</b>	2 x 3"	1	1.00
<b>Column Reducing Tee</b>	2 x 2 x 1½"	1	8.00
<b>Column Outlet Nipple</b>	1½" x 2"	1	.40
<b>Condenser Elbow</b>	1½"	1	3.49
<b>Condenser Top Nipple</b>	1½" x 2"	1	.40
<b>Condenser Reducing Coupling</b>	1½" x 1"	1	3.12
<b>Condenser Core</b>	1" x 23"	1	2.30
<b>Condenser Core Output Reducer</b>	1" x ½"	1	1.34
<b>Condenser Core Input Reducer</b>	1½" x 1"	1	3.12
<b>Condenser Jacket</b>	1½" x 16¾"	1	1.70
<b>Condenser Cooling Reducing Tee's</b>	1½" x 1½" x ½"	2	10.26
<b>Condenser Cap Nipples</b>	1½" x 2¼"	2	.50
<b>Condenser Caps</b>	1½"	2	.80

**BUILDING A HOME DISTILLATION APPARATUS**

<b>Cooling Tubes</b>	½" x 8"	2	6.40
<b>Stainless Hose Clamp</b>	2"	1	1.50
<b>Brass Screen</b>	9 sq. in.	1	.90
<b>Reflux Column</b>	2" x 36"	1	11.70
<b>Column Coupling</b>	2"	1	3.00
<b>Column Flange</b>	2"	1	1.75
<b>Total</b>			<b>\$64.68</b>

## Appendix II - Resources

### Resource Links

**Exhaust Flanges, Tubing Benders, Gasket Punches, Thread-Sert Kits**

J.C. Whitney Automotive Supply <http://JCWhitney.com> 1-800-529-4486

**Tools, Gas Burners, Regulators, Pumps**

Northern Tool & Equipment – <http://NorthernTool.com> 1-800-533-5545

Harbor Freight Tools – <http://HarborFreight.com> 1-800-423-2567

**Stainless Steel Milkcans**

MCMMASTER-CARR <http://www.mcmaster.com/> (630) 833-0300

Dairy Service Inc.

Box 253

Bluffton, IN 46714

Phone: 219-824-1100

Attn: Paul Newhouse

Holmco Container Manufacturing, Inc.

1542 Country Hy 600

Baltic, OH 43804

Phone: 330-893-2464

Attn: Mr. Norm Raber