

The MK series pumps are designed to complete the existing MG series with improve performances in terms of flow rate, pressure, capability to handle high viscosity fluids and a wider offer of materials to suit most applications, from the food to the industrial and chemical markets. The pump's housing and the internal metal parts are available in AISI 303, AISI 316L or SAF 2205. The gears are available in PTFE™ or Peek™. The driving magnet, available in Ferrite or in rare earths, is capable to drive the pump at high pressure. The quality of the materials of the assembled components allows handling of fluids with temperatures up to 120 °C (248 °F). The low noise and pulsation is the result of precision gears accurately assembled and balanced within the housing combined with the magnetic coupling wich grants the perfect alignment. The Sanitary design makes this pump series the preferred candidate for use in medical applications where trouble-free products are needed.

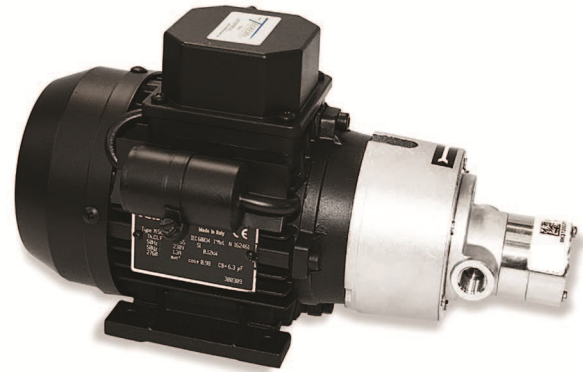

### MAIN APPLICATION

- Medical and surgical
- Hemodialysis apparatus
- Laser apparatus
- Lubrication
- Ink-jet printing systems
- Cooling systems
- Laboratory instrumentation
- Water treatment
- Sampling
- Food processing



### TECHNICAL INFORMATION

Pump housing material	Stainless steel	Max static pressure	20 bar/290 psi
Gears and bushing materials	Peek™/PTFE™	Temperature range	Peek™ -45 to 120 °C/-49 to 248 F
Ports	1/4" GAS or NPT		Ceramic Peek™ -45 to 120 °C/-49 to 248 F
Pump weight (MK313)	700 g (1.5 lb)		PTFE™ -45 to 50 °C/-49 to 122 F
Speed limit	5000 rpm	Max vacuum	724 mmHg/28.5 inHg
*Wet lift with water	~ 8m/26.7 ft		

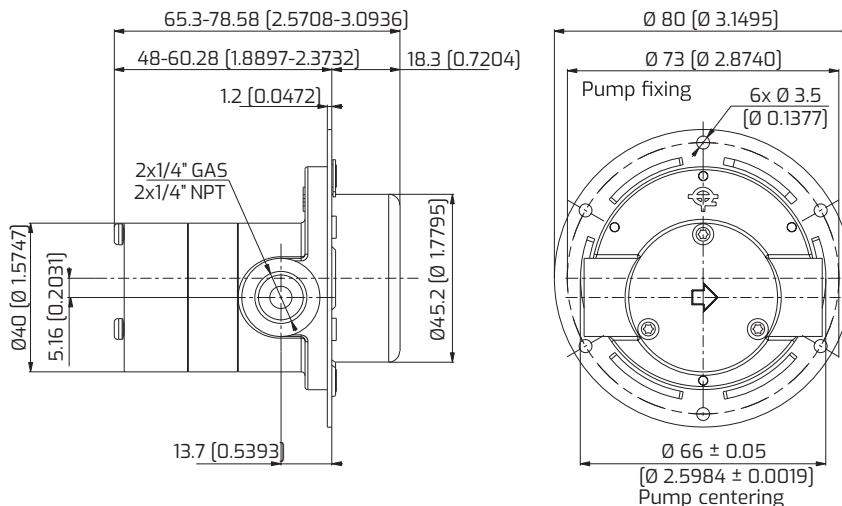

Overall dimensions depend from motor size



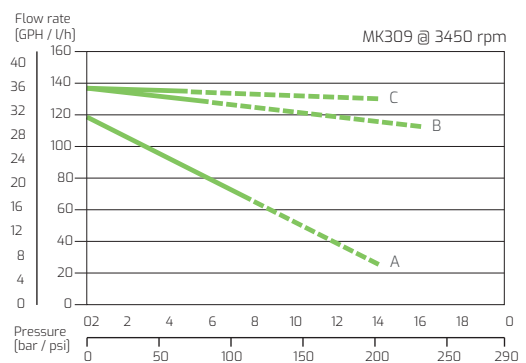
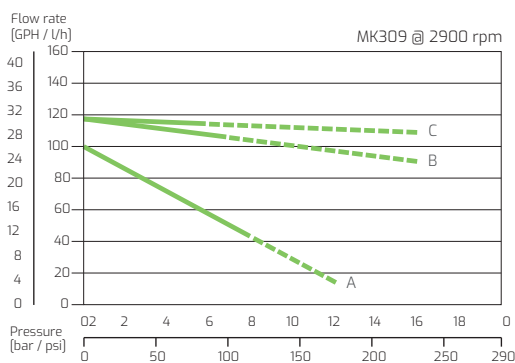
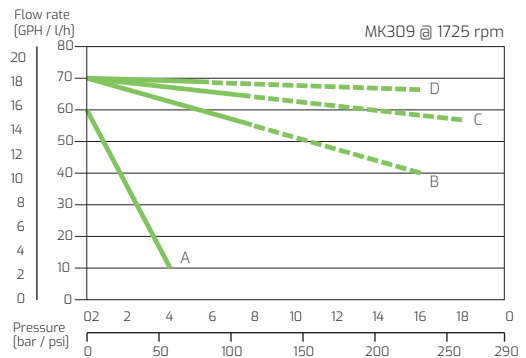
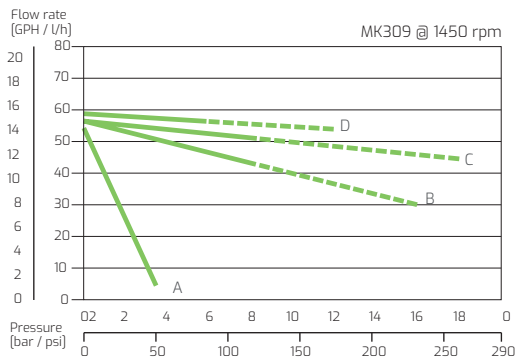

— Operating range with ferrite magnet      A = 1 cSt    B = 20 cSt    C = 75 cSt    D = 180 cSt    E = 210 cSt  
 - - - Operating range with rare earth magnet

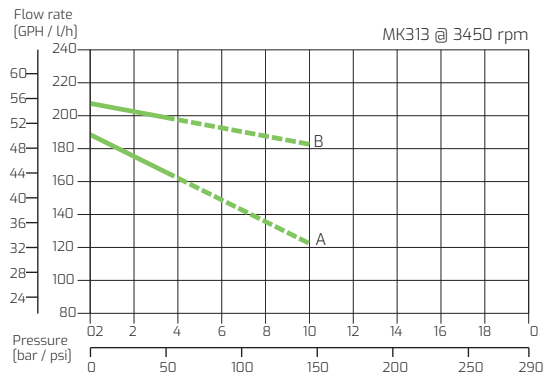
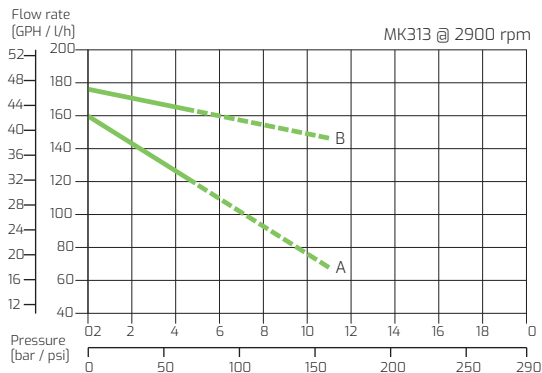
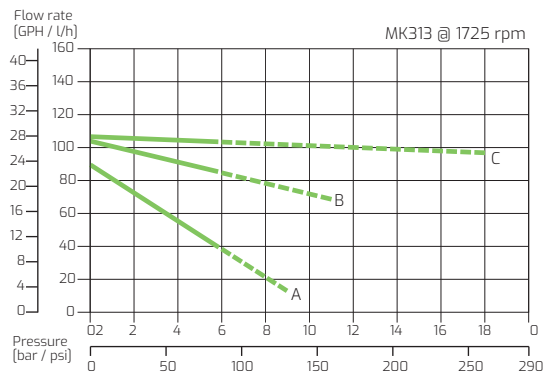
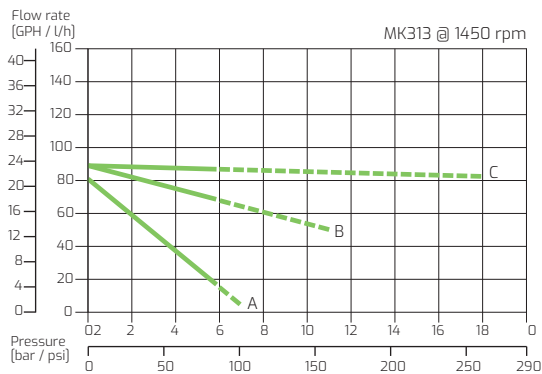

A = 1 cSt    B = 20 cSt    C = 75 cSt    D = 180 cSt    E = 210 cSt



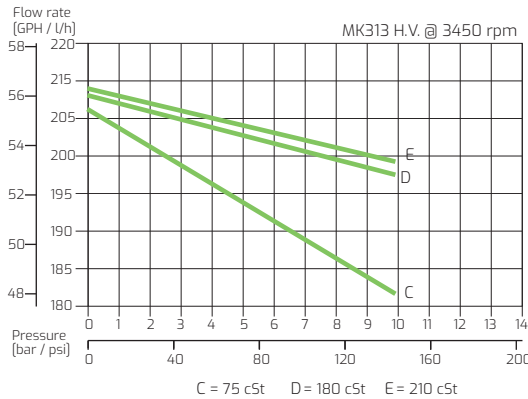
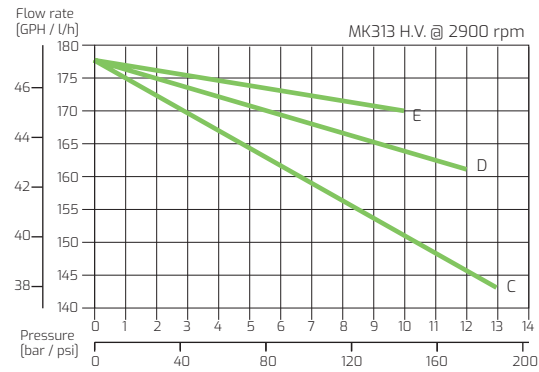
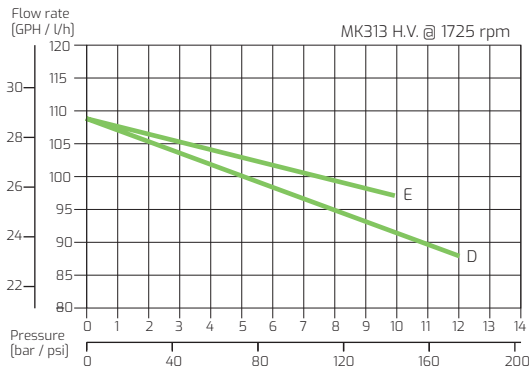

Note: Characteristics with water at 20 °C (68 F) and without relief valve. Fluids different from water must be validated by the Customer. Temperature requirements different from ambient temperature must be mentioned on the order. Different materials are available upon request. Use a filter before the pump inlet no larger than 10 micron

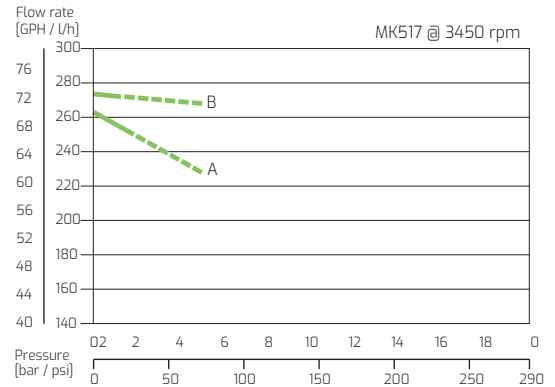
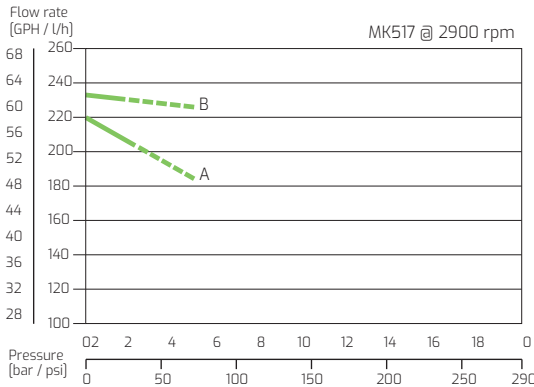
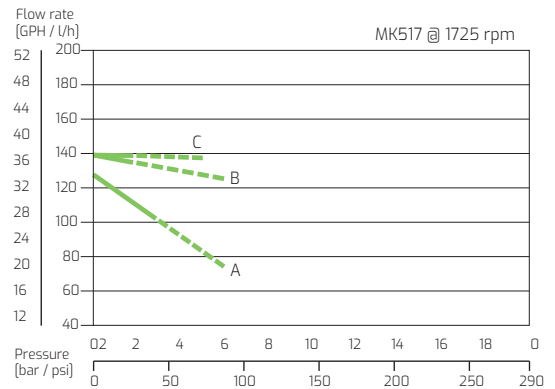
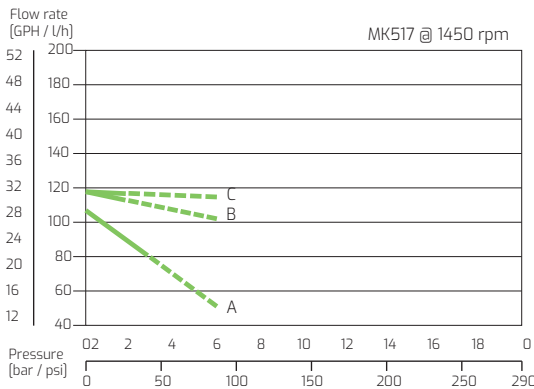

— Operating range with ferrite magnet    A = 1 cSt    B = 20 cSt    C = 75 cSt    D = 180 cSt    E = 210 cSt  
 - - - Operating range with rare earth magnet



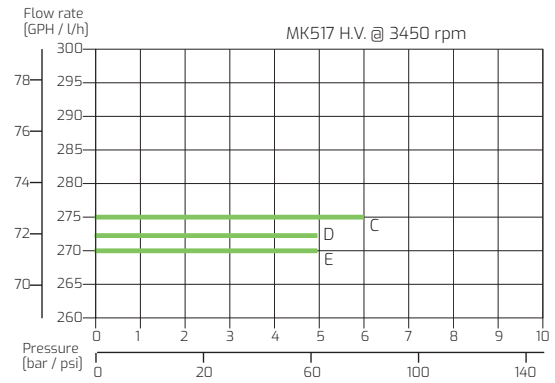
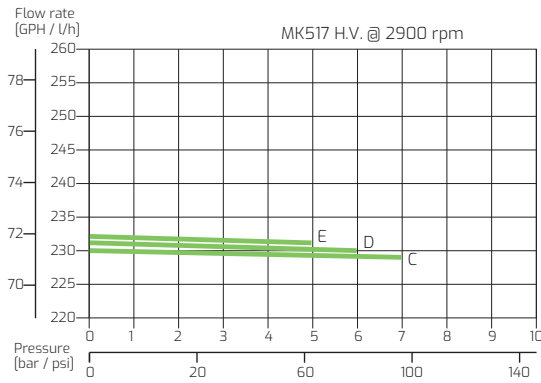
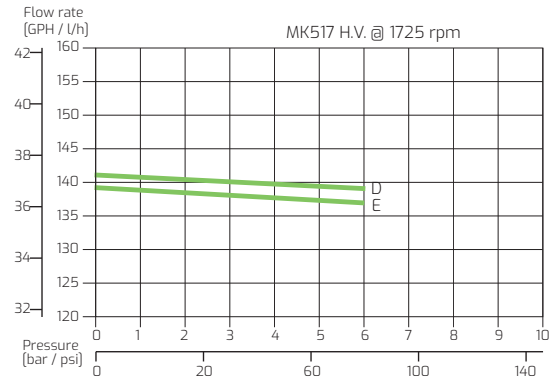
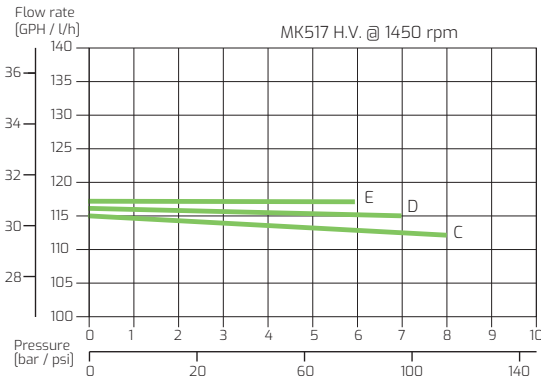

C = 75 cSt    D = 180 cSt    E = 210 cSt

Note: Characteristics with water at 20 °C (68 F) and without relief valve. Fluids different from water must be validated by the Customer.  
 Temperature requirements different from ambient temperature must be mentioned on the order.  
 Different materials are available upon request. Use a filter before the pump inlet no larger than 10 micron

