

**High-performance Digital Display Pressure Sensor  
DP-100 Series**

MJE-DP100 No.0067-28V

Thank you very much for purchasing Panasonic products. Read this Instruction Manual carefully and thoroughly for the correct and optimum use of this product. Kindly keep this manual in a convenient place for quick reference.

**WARNING**

- Never use this product as a sensing device for personnel protection.
- In case of using sensing devices for personnel protection, use products which meet laws and standards, such as OSHA, ANSI or IEC etc., for personnel protection applicable in each region or country.
- This product is used for noncorrosive gas. The product shall not be used for liquid or corrosive gas. Never use fluids having inflammability, toxicity, etc., that affect the human body, either.
- A product intended for use in Japan conforms to the Japanese Measurement Act. Do not use a product intended for use overseas in Japan.

**1 PART DESCRIPTION**

**Output 1 operation indicator**  
Lights up when comparative output 1 is ON

**Output 2 / analogue voltage / current output operation indicator**  
Lights up when comparative output 2 is ON  
**High-function type:**  
Lights up when analogue voltage / current output is set

**Pressure port**  
DP-100 type: R<sup>1</sup>/<sub>8</sub> + M5 female screw  
DP-100-E type: G<sup>1</sup>/<sub>8</sub> + M5 female screw  
DP-100-M type: M5 female screw  
DP-100-N type: NPT<sup>1</sup>/<sub>8</sub> + M5 female screw

Notes: 1) In the case of a model that is intended for use outside Japan, attach the unit switch plate corresponds to the set pressure unit.  
2) The product for use inside Japan can be set only to "MPa" or "kPa."

**2 PIPING**

- When connecting a commercial coupler to the pressure port, attach a 12mm spanner (14mm for DP-100-E type) to the pressure port's hexagon section to fix the port, and then tighten with a tightening torque of 9.8N·m or less (M5 female: 1N·m or less). The commercial coupler or pressure port section will be damaged if the tightening torque is excessive. Wrap sealing tape around the coupler when connecting to prevent leaks.

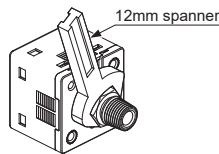

**3 MOUNTING**

- The sensor mounting bracket MS-DP1-1 is available as an option. When mounting the sensor onto the sensor mounting bracket, etc., the tightening torque should be 0.5N·m or less.

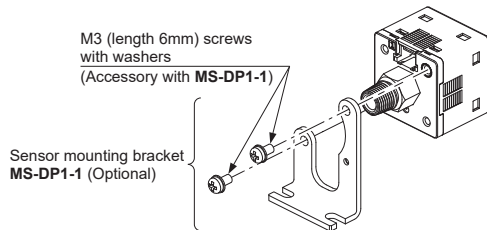

- The panel mounting bracket MS-DP1-2 (optional) and MS-DP1-4 (optional), as well as the front cover MS-DP1-3 (optional) and DPX-04 (optional) are also available.
- The type of the front cover is different depending on the applied mounting bracket. Use MS-DP1-3 for MS-DP1-2, and DPX-04 for MS-DP1-4.
- For mounting of the panel mounting bracket, refer to the Instruction Manual enclosed with MS-DP1-2 or MS-DP1-4.

**4 WIRING**

**Connection method**

- Insert the cable with connector CN-14A-C into this product's connection connector section as shown in the right figure.

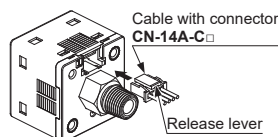

**Disconnection method**

- Pressing the release lever of the cable with connector, pull out the connector.

**<Recommended product>**  
Contact: SPHD-001T-P0.5  
Housing: PAP-04V-S  
[JST Mfg. Co., Ltd.]

Note: Do not pull by holding the cable without pressing the release lever, as this can cause cable break or connector break.

**<Connection connector pin arrangement>**

Connector pin No.	Terminal name
1	+V
2	Comparative output 1
3	Standard type: Comparative output 2 High-function type: Analogue voltage / current output or external input
4	0V

**5 I/O CIRCUIT DIAGRAMS**

**NPN output type**

**Standard type**

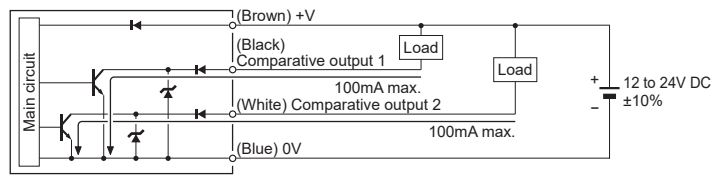

**High-function type**

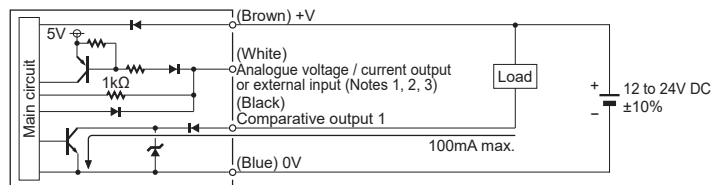

**PNP output type**

**Standard type**

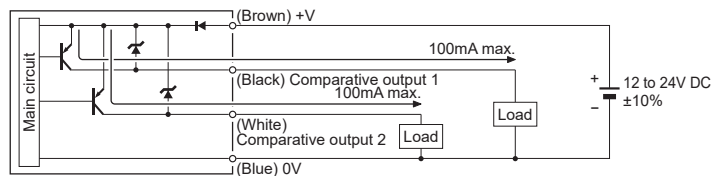

**High-function type**

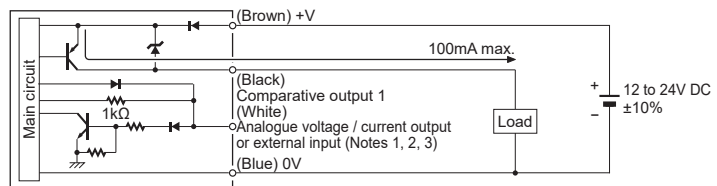

Notes: 1) When the analogue current is output, the output load resistance should be 250Ω max.  
2) Take care that when the analogue current is output, 5V or more voltage generates.  
3) When using the analogue voltage output, be careful to the input impedance of the connected device. Furthermore, note that if the cable is extended, the cable resistance will cause the voltage to drop.

**6 OUTPUT MODE AND OUTPUT OPERATION**

- The EASY mode, hysteresis mode or window comparator mode can be selected as the output mode for comparative output 1 and comparative output 2. Refer to **<Comparative output 1 / 2 output mode setting>** in "8 MENU SETTING MODE" for details.

**EASY mode**

- ON / OFF of the comparative output is controlled in this mode.

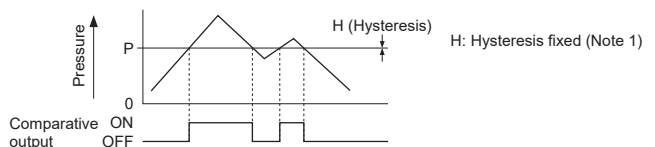

Notes: 1) Hysteresis can be fixed in 8 steps. Refer to **<Hysteresis fixed value selection>** in "3 PRO MODE" for setting.  
2) "P-1" is displayed for comparative output 1 and "P-2" for comparative output 2 on the sub-display.

**Hysteresis mode**

- The comparative output ON / OFF state can be controlled with randomly set hysteresis in this mode.

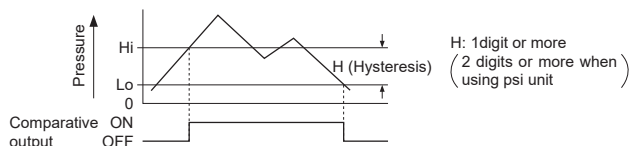

Note: "Hi-1" or "Lo-1" is displayed for comparative output 1 and "Hi-2" or "Lo-2" for comparative output 2 on the sub-display.

## Window comparator mode

- In this mode, the ON or OFF state of the comparative output is controlled with a pressure in the set range.

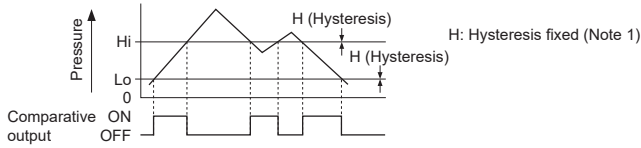

- Notes: 1) Hysteresis can be fixed in 8 steps.  
Refer to <Hysteresis fixed value selection> in "PRO MODE" for setting.  
2) "H<sub>1</sub>-1" or "Lo-1" is displayed for comparative output 1 and "H<sub>1</sub>-2" or "Lo-2" for comparative output 2 on the sub-display.  
3) Set the interval between the Lo side and Hi side to hysteresis fixed value or more.

## 7 RUN MODE

### Setting the threshold value

- Refer to <Comparative output 1 / 2 output mode setting>, <Analogue voltage / current output / external input selection> in "MENU SETTING MODE" for setting conditions.
- The Sub display conducts the threshold value. Main display does not changed.

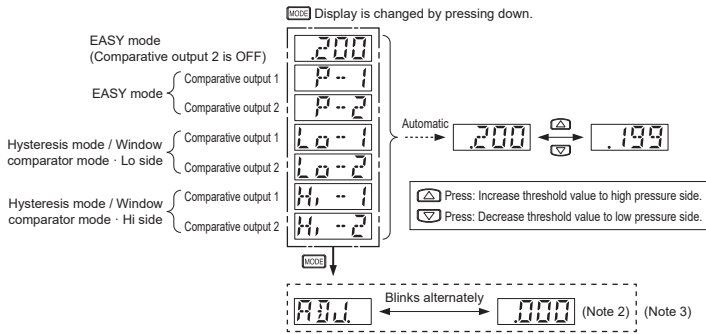

- Notes: 1) If the set pressure range is exceeded, "UP" (exceeds the upper limit) or "DOWN" (exceeds the lower limit) will appear on the sub display. "DOWN" will also appear if the Hi side threshold value exceeds the Lo side threshold value when setting the "hysteresis mode / window comparator mode" threshold value.  
2) Auto-reference value and remote zero-adjustment value are displayed.  
For details, refer to "AUTO-REFERENCE FUNCTION" and "REMOTE ZERO-ADJUSTMENT FUNCTION."  
3) In the dash line box is not displayed when not setting "AREF" or "ZERO" in external input switch. For the setting method, refer to <Analogue voltage / current output / external input selection> in "MENU SETTING MODE."

### Zero-adjustment function

- The zero-adjustment function forcibly sets the pressure value to "zero" when the pressure port is opened.



### Key lock function

- The key lock function prevents key operations so that the conditions set in each setting mode are not inadvertently changed.

#### <Key lock set>

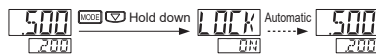

#### <Key lock released>



### Peak / bottom hold function

- The peak / bottom hold functions display the peak value and bottom value of the fluctuating pressure.
- The peak value is displayed on the main display and the bottom value is displayed on the sub-display.
- The higher vacuum side indicates the peak value, while the lower vacuum side indicates the bottom value.

#### <Peak / bottom hold set>



#### <Peak / bottom hold released>



## 8 MENU SETTING MODE

- The mode will change to RUN mode when the mode selection key is held down during this setting process. In doing so, changed items before holding down the mode selection key have been set.

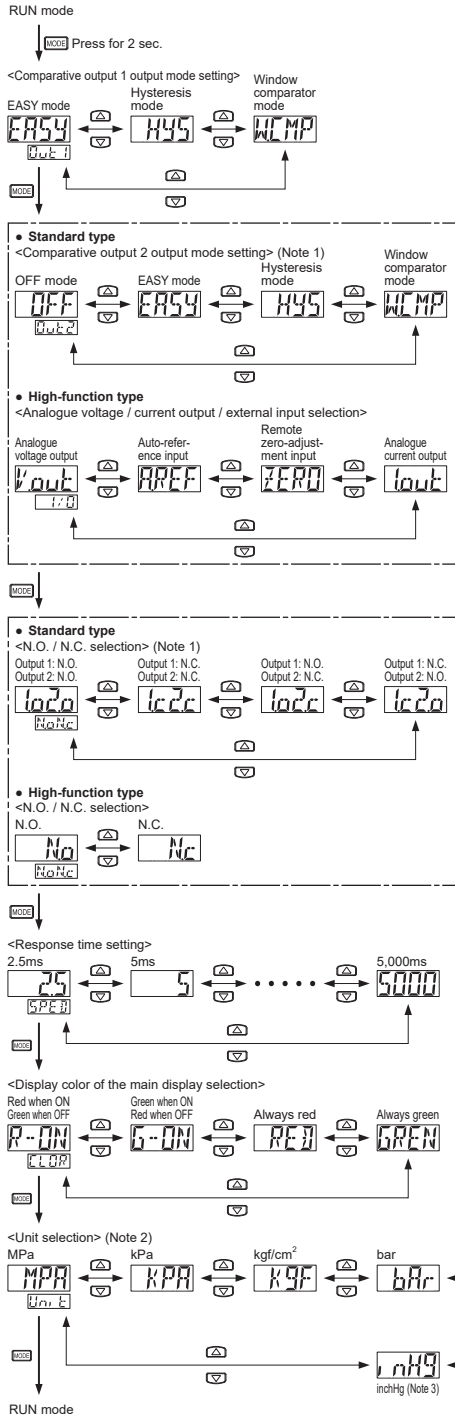

- Notes: 1) If the comparative output 2 output mode setting is set to "OFF", the display of N.O. / N.C. selection is the same as the high-function type.  
2) In case Japanese, only "MPa" or "kPa" can be set. In the case of a low pressure type, the unit switch setting item is not displayed.  
3) This is not displayed on the high pressure type.

Setting item	Factory setting	Description
Comparative output 1 output mode setting	EASY	Sets the output operation of comparative output 1.
Comparative output 2 output mode setting (Standard type only)	OFF	Sets the output operation of comparative output 2.
Analogue voltage / current output / external input selection (High-function type only)	Vout	Selects analogue voltage / current output, auto-reference input, or remote zero-adjustment input.
N.O. / N.C. selection	Low pressure type: Nc High pressure type: No	Normal open (N.O.) or normal close (N.C.) can be selected.
Response time setting	25	Sets the response time. The response time can be selected from 2.5ms, 5ms, 10ms, 25ms, 50ms, 100ms, 250ms, 500ms, 1,000ms or 5,000ms.
Displayed color of the main display selection	R-ON	Displayed color of the main indicator can be changed.
Unit selection	Low pressure type: KPa High pressure type: MPa	Pressure unit can be changed.

## 9 PRO MODE

- The mode will change to RUN mode when the mode selection key is held down during this setting process. However, changed items before holding down the mode selection key have been set.

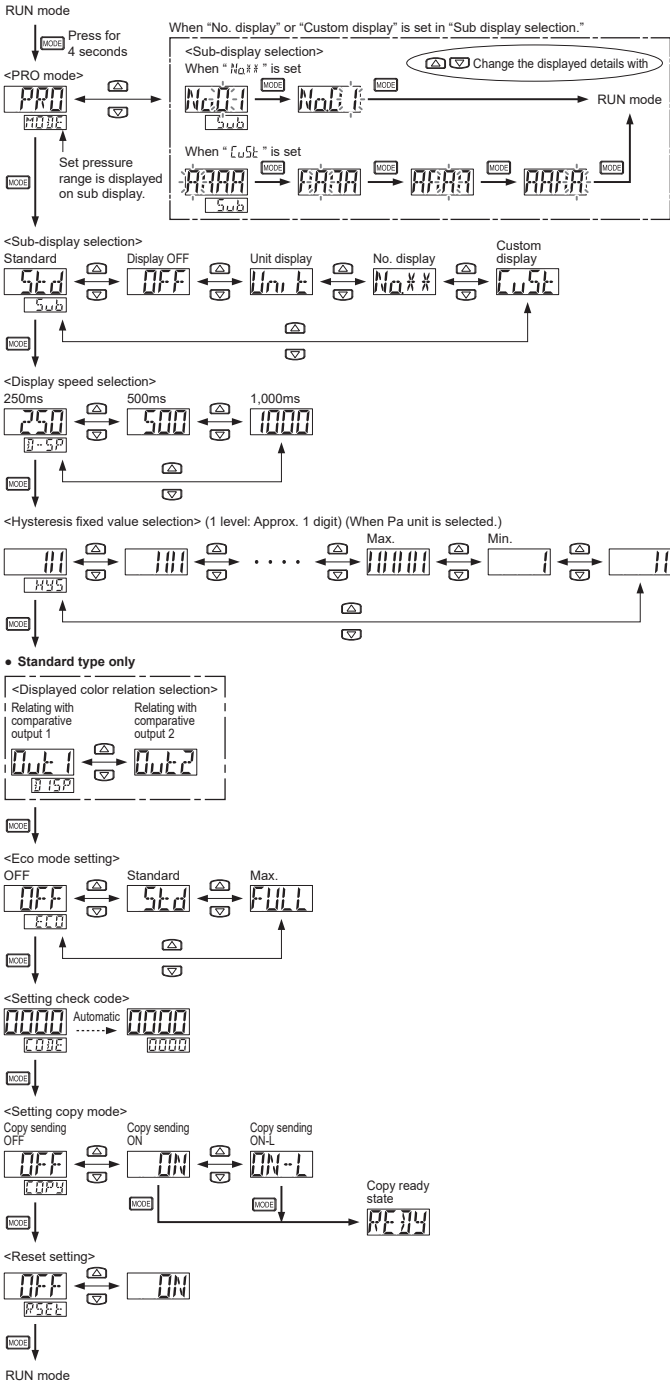

Setting item	Factory setting	Description
Sub-display selection	5.00	Changes the indication of the sub-display. "OFF" : Displays nothing. "Unit" : Presently selected pressure unit is displayed. "No.##" : Desired No. can be shown. "Cust." : Desired numbers, alphabets (some of them cannot be displayed) and signs can be shown.
Display speed selection	250	Changes the speed of the displayed pressure value on the main display.
Hysteresis fixed value selection	0.0	Sets hysteresis of the EASY mode and the window comparator mode. (8 steps)
Displayed color relation selection (Standard type only)	0.0	The setting contents set at the displayed color setting in Menu setting mode can be related with either comparative output 1 or comparative output 2.
Eco mode setting	OFF	Current consumption can be lowered. "OFF" : Normal operation (ECO mode is off.) "Std" : If any key operation is not carried out for approx. 5 sec. in RUN mode, the display becomes dark. "Full" : If any key operation is not carried out for approx. 5 sec. in RUN mode, the display is turned off. Press any key to temporarily show the normal indication.
Setting check code	0.000	Current setting contents can be checked. For codes, refer to "Code table".
Setting copy mode	OFF	The setting of the master side sensor can be copied to the slave side sensors. For details, refer to "10 SETTING COPY FUNCTION". "ON" : The setting contents are copied. "ON-L" : The setting contents are copied, and the slave side sensor goes into key-lock state.
Reset setting	OFF	Returns to default settings (factory settings). By pressing down mode key when "ON" mode, becomes default settings (factory settings).

## Code table

### • Main display (1st digit form left)

Code	1st digit		2nd digit		3rd digit	4th digit	
	Comparative output 1 output mode	N.O. / N.C. selection	Standard type	High-function type		Threshold display	Displayed color of the main display
0	EASY	N.O.	OFF	OFF	Analogue voltage output	P-1, Lo-1	Comparative output 1
1		N.C.		N.O.	Auto reference	Hi-1	Comparative output 2
2		N.O.	EASY	N.C.	Remote zero-adjustment	P-2, Lo-2	Comparative output 1
3		N.C.		N.O.	Analogue current output	Hi-2	Comparative output 2
4	Window comparator	N.O.	Hysteresis	N.C.	-	ADJ.	Always red
5		N.C.	Window comparator	N.O.	-	-	Comparative output 1
6		-		N.C.	-	-	Comparative output 2
7		-		-	-	-	Always green

### • Sub-display (5th digit from left)

Code	5th digit	6th digit	7th digit	8th digit
	Response time	Unit selection	Display speed	Eco mode
0	2.5ms	MPa	250ms	OFF
1	5ms	kPa	500ms	Std
2	10ms	kgf/cm <sup>2</sup>	1,000ms	Full
3	25ms	bar	-	-
4	50ms	psi	-	-
5	100ms	mmHg	-	-
6	250ms	inchHg	-	-
7	500ms	-	-	-
8	1,000ms	-	-	-
9	5,000ms	-	-	-

## 10 SETTING COPY FUNCTION

- This can copy the settings of the master side sensor to the slave side sensor.
- Be sure to use the setting copy function between the identical models. This function cannot be used between different models.
- Only one sensor can be connected on slave side with a master side sensor for the setting copy function.

### Setting procedure

- Set the setting copy function of the master side sensor to "Copy sending ON" or "Copy sending ON-L", and then press the mode selection key so that the sensor is in copy ready state. For details, refer to <Setting copy mode> in "9 PRO MODE".
- Turn OFF the master side sensor.
- Connect the master side sensor with the slave side sensor as shown below.

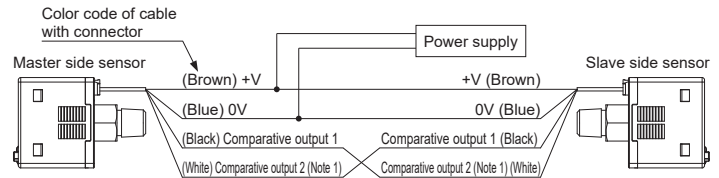

Notes: 1) For the high-function type, external input.

- Turn ON the master side sensor and the slave side sensor at the same time. (Note 2) (Note 3)
- Set contents (16-bit coded) are shown in orange on the main display of the master side sensor and the copying starts.
- The same code explained above is shown in green on the main display of the slave side sensor, and "OK" is shown on the sub-display (When copying is complete.)
- Turn OFF the power of the master side sensor and the slave side sensor and disconnect the wire.

\* If copying the setting to another sensor repeatedly, follow steps 3 to 7.

Notes: 2) Take care that if the power is not turned on at the same time, the setting contents may not be copied.  
3) Note that when the power is on, pulse output is output to comparative output 1.

### To cancel the setting copy mode of master side sensor

- Whilst the slave side sensor is disconnected, turn on the power of the master side sensor.
- Press the mode selection key for approx. 2 seconds.

## 11 AUTO-REFERENCE FUNCTION (ONLY HIGH-FUNCTION TYPE)

- The auto-reference function corrects the set value using the detected pressure value during auto-reference input as the reference pressure.
- Using the detected pressure value at auto-reference input P(a) as a reference, the set value T is automatically corrected to "set value 1 + P(a)".

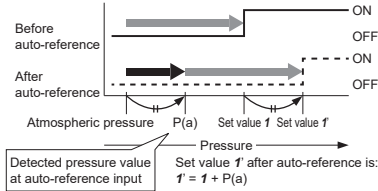

### Settable range and set pressure range after correction

- The set pressure range is wider than the rating pressure range so that the auto-reference function can be handled.

If the corrected set value exceeds the set pressure range when auto-reference input is carried out, the set value will be automatically corrected to within the set pressure range. Thus, take care not to exceed the set pressure range.

### Operation chart

During normal operation (each comparative output set to N.O.)

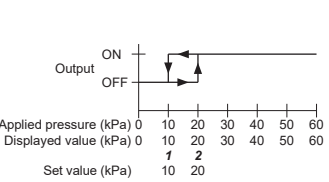

During auto-reference input (each comparative output set to N.O.)

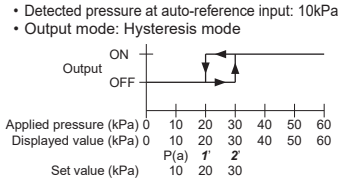

Note: The set values shift in the same manner during the EASY mode or the window comparator mode.

- The detected pressure value at auto-reference input becomes "zero" when the setting of the external input selection function is changed or the power is turned ON again.
- The auto-reference input value can be checked when setting the threshold value in RUN mode. Refer to the threshold value setting in "7 RUN MODE" for details.

## 12 REMOTE ZERO-ADJUSTMENT FUNCTION (HIGH-FUNCTION TYPE)

- The remote zero-adjustment function forcibly sets the pressure value to "zero" when the external signal is inputted.

The set value is not corrected when remote zero-adjustment is input. Make sure that the pressure and set value during remote zero-adjustment do not exceed the set pressure range.

### Operation chart

During normal operation (each comparative output set to N.O.)

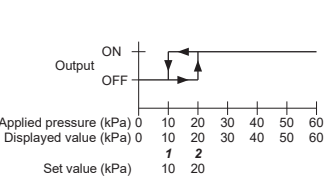

During remote zero-adjustment input (each comparative output set to N.O.)

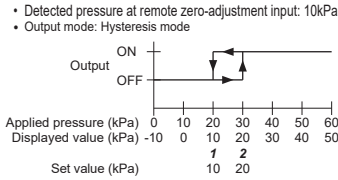

Note: The setting values shift in the same manner during the EASY mode or the window comparator mode.

- The remote zero-adjustment value is cleared when the setting of the external input selection is changed or the power is turned ON again, and normal operation based on the atmospheric pressure is resumed.
- The remote zero-adjustment value can be confirmed when setting the threshold value in RUN mode. Refer to the threshold value setting in "7 RUN MODE".

## 13 ERROR INDICATION

Error message	Cause	Corrective action
E-1	The load is short-circuited causing an overcurrent to flow.	Turn the power OFF and check the load.
E-3	Pressure is applied during zero-point adjustment.	Applied pressure at the pressure port should be brought to atmospheric pressure and zero-point adjustment should be done again.
E-4	External input is carried out outside the rated pressure range.	Applied pressure range should be brought within the rated pressure range.
E-5	Communication error (Disconnection, faulty connection, etc.)	Check the wiring when using the copy function.
E-6	Communication error (Incorrect model.)	Make sure that the system is configured of the same models when using the copy function.
10 10	The applied pressure exceeds the upper limit of the display pressure range.	Applied pressure range should be brought within the rated pressure range.
10 10	The applied pressure exceeds the lower limit of the display pressure range.	

When other error message is displayed, contact us.

## 14 SPECIFICATIONS

### Model

DP-10 [1] [2] [3] [-4] [-5] [-6]

[1]: 1: Low-pressure type, 2: High-pressure type

[2]: None: For outside of Japan, Z: For inside of Japan

[3]: None: Standard type, A: High-function type

[4]: None: R<sup>1</sup>/<sub>8</sub> + M5 female screw, E: G<sup>1</sup>/<sub>8</sub> + M5 female screw, M: M5 female screw

N: NPT<sup>1</sup>/<sub>8</sub> + M5 female screw

[5]: None: NPN output type, P: PNP output type

[6]: None: Cable with connector enclosed, J: No cable with connector

Item	Standard type		High-function type	
	Low-pressure type	High-pressure type	Low-pressure type	High-pressure type
Pressure type	Gauge pressure			
Rated pressure range	-100 to +100kPa	-0.1 to +1.0MPa	-100 to +100kPa	-0.1 to +1.0MPa
Set pressure range	-101.0 to +101.0kPa	-0.101 to +1.010MPa	-101.0 to +101.0kPa	-0.101 to +1.010MPa
Withstand pressure	500kPa	1.5MPa	500kPa	1.5MPa
Applicable fluid	Non-corrosive gas			
Supply voltage	12 to 24V DC ±10%			
Power consumption (Note 1)	Normal operation: 720mW or less (current consumption 30mA or less at 24V supply voltage) ECO mode (STD): 480mW or less (current consumption 20mA or less at 24V supply voltage) ECO mode (FULL): 360mW or less (current consumption 15mA or less at 24V supply voltage)			
Comparative output	<NPN output type>		<PNP output type>	
	NPN open-collector transistor • Maximum sink current: 100mA • Applied voltage: 30V DC or less (between comparative output and 0V) • Residual voltage: 2V or less (at 100mA sink current)		PNP open-collector transistor • Maximum source current: 100mA • Applied voltage: 30V DC or less (between comparative output and +V) • Residual voltage: 2V or less (at 100mA source current)	
Output operation	Selectable either N.O. or N.C., with key operation			
Hysteresis	Min. 1 digit (variable) (however, 2 digits when using psi units)			
Repeatability	±0.1% F.S. ± within 2 digits   ±0.2% F.S. ± within 2 digits   ±0.1% F.S. ± within 2 digits   ±0.2% F.S. ± within 2 digits			
Response time	2.5ms, 5ms, 10ms, 25ms, 50ms, 100ms, 250ms, 500ms, 1.000ms or 5.000ms selectable with key operations			
Analogue voltage output	<High-function, low-pressure type>		<High-function, high-pressure type>	
	• Output voltage: 1 to 5V • Zero point: Within 3V ± 5% F.S. • Span: Within 4V ± 5% F.S. • Linearity: Within ± 1% F.S. • Output impedance: Approx. 1kΩ		• Output voltage: 0.6 to 5V • Zero point: Within 4mA ± 5% F.S. • Span: Within 4.4V ± 5% F.S. • Linearity: Within ± 1% F.S. • Output impedance: Approx. 1kΩ	
Analogue current output	<High-function, low-pressure type>		<High-function, high-pressure type>	
	• Output current: 4 to 20mA • Zero point: Within 12mA ± 5% F.S. • Span: Within 16mA ± 5% F.S. • Linearity: Within ± 1% F.S. • Load resistance: 250Ω (max.)		• Output current: 2.4 to 20mA • Zero point: Within 4mA ± 5% F.S. • Span: Within 17.6mA ± 5% F.S. • Linearity: Within ± 1% F.S. • Load resistance: 250Ω (max.)	
External input	<High-function NPN output type>		<High-function PNP output type>	
	• ON voltage: 0.4V DC or less • OFF voltage: 5 to 30V DC or open • Input impedance: Approx. 10kΩ • Input time: 1ms or more		• ON voltage: 5V to +V DC • OFF voltage: 0.6V DC or less or open • Input impedance: Approx. 10kΩ • Input time: 1ms or more	
Overvoltage category	1			
Ambient temperature	-10 to +50°C (No dew condensation or icing allowed), Storage: -10 to +60°C			
Ambient humidity	35 to 85% RH, Storage: 35 to 85% RH			
Pollution degree	2			
Temperature characteristics	Within ±0.5% F.S. (at +20°C reference)	Within ±1% F.S. (at +20°C reference)	Within ±0.5% F.S. (at +20°C reference)	Within ±1% F.S. (at +20°C reference)
Material	Enclosure: PBT (with glass fiber), LCD display: Acrylic, Pressure port: Stainless steel (SUS 303) Mounting screw section: Brass (nickel-plated), O-ring: H-NBR, Key part: Silicon rubber			
Weight	Approx. 40g (DP-10-E type: Approx. 45g, DP-10-M type: Approx. 30g) (Main body only)			
Accessories	CN-14A-C2 (Cable with a connector, 2m long) (optional for J type): 1 pc. Unit switching label: 1 pc. (for outside of Japan only)			

Note: Current consumption does not include the analog current output.

## 15 CAUTIONS

- This product has been developed / produced for industrial use only.
- This product is suitable for indoor use only.
- The operating altitude of this product is 2,000m or less.
- Use within the rated pressure range.
- Do not apply pressure exceeding the pressure withstandability value. The diaphragm will get damaged and correct operation shall not be maintained.
- Make sure that the power supply is off while wiring.
- Take care that wrong wiring will damage the sensor.
- Verify that the supply voltage variation is within the rating.
- If power is supplied from a commercial switching regulator, ensure that the frame ground (F.G.) terminal of the power supply is connected to an actual ground.
- In case noise generating equipment (switching regulator, inverter motor, etc.) is used in the vicinity of this sensor, connect the frame ground (F.G.) terminal of the equipment to an actual ground.
- Do not use during the initial transient time (0.5 sec.) after the power supply is switched on.
- Extension up to total 100m or less, is possible with more than 0.3mm<sup>2</sup> of electric conductor cross-sectional area cable.
- In case of using this product as a CE Marking conformity product, the wire connected to this product must be within 30m.
- When this product is used as a Korean S-mark conformity product, the power line cable connected to this product should be within 10m.
- Do not run the wires together with high-voltage lines or power lines or put them in the same raceway. This can cause malfunction due to induction.
- The specification may not be satisfied in a strong magnetic field.
- Avoid dust, dirt, and steam.
- Take care that the sensor does not come in direct contact with water, oil, grease, or organic solvents, such as, thinner, etc.
- Do not insert wires, etc. into the pressure port. The diaphragm will get damaged and correct operation shall not be maintained.
- Do not operate the keys with pointed or sharp objects.
- Make sure that stress by forcible bend or pulling is not applied directly to the sensor cable joint.

## 16 INTENDED PRODUCTS FOR CE MARKING

- The models listed under "14 SPECIFICATIONS" come with CE Marking. As for all other models, please contact our office.



## Panasonic Industrial Devices SUNX Co., Ltd.

<https://panasonic.net/id/pidsx/global>

Overseas Sales Division (Head Office)

2431-1 Ushiyama-cho, Kasugai-shi, Aichi, 486-0901, Japan

Phone: +81-568-33-7861 FAX: +81-568-33-8591

About our sale network, please visit our website.

PRINTED IN JAPAN

© Panasonic Industrial Devices SUNX Co., Ltd. 2019